

SL-V800-26

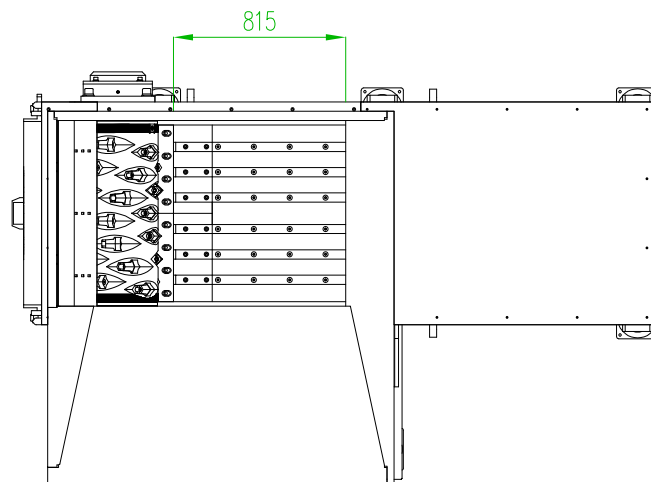
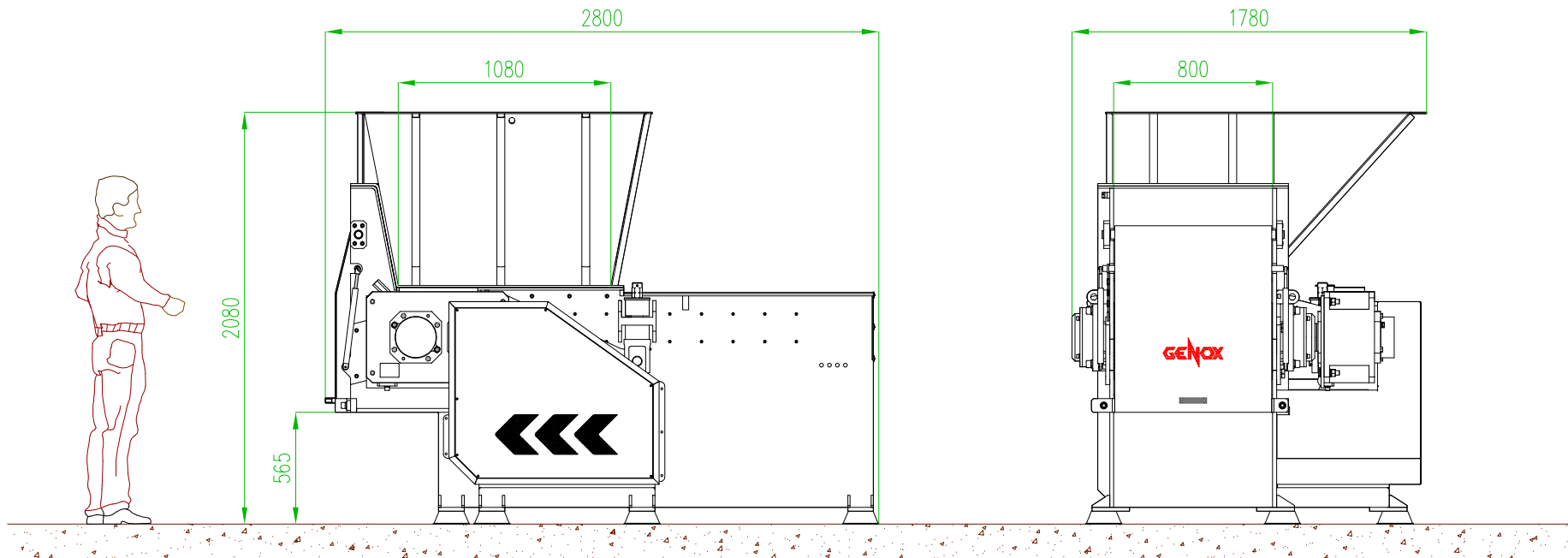

STANDARD SPECIFICATION:

ROTOR DIAMETER: 400 MM
 ROTOR WIDTH: 800 MM
 ROTOR BLADES: 35 PCS
 FIXED BLADES: 4 PCS
 ROTOR SPEED: 80 RPM
 DRIVE POWER: 37 KW
 HYDRAULIC POWER: 3.75 KW

STANDARD PAINT SHADES:

MACHINE BODY (RAL 7030 - STONE GREY)
 HOPPER (RAL 7022 - UMBRA GREY)
 MAINTENANCE PARTS & MOTORS (RAL 1003 - SIGNAL YELLOW)

 <small>GENOX RECYCLING TECHNOLOGY (UK) LTD 2 CURZON ROAD, OFFERTON STOCKPORT, CHESHIRE UNITED KINGDOM SK2 5DH</small>		V800 SINGLE SHAFT SHREDDER STANDARD LAYOUT DIMENSIONS
DATE	SCALE	SL-V800-26
19/3/2026	N.T.S.	
DRAWN BY: J. DAKIN		