

ROBUST 

SHREDDERS

Be IN think GREEN



SHREDDERS ROBUST

Be IN think GREEN

At Robust, we produce and sell shredders of wood, wood waste and scrap, pallets, plastics and similar materials under the registered trade mark ROBUST. The shredders uses hardened cutting knives on a rotor to tear and crush the material pushed towards the rotor by the hydraulic pressure unit. Granulation of the output material depends on the size of openings in the sieve installed behind the rotor.

INNOVATIVE SOLUTIONS

We received the 2017, 2016 and 2012 Innovator of the Year Recognition from the region Spodnja Savinjska dolina. The Recognition 2017 is for crushing rollers for pre-shredding of volumetric recycling products, 2016 is for Pre-shredder ROBUST P130 as a freestanding pre-shredder or an upgrade for ROBUST universal shredders and other shredders, 2012 for our "segment rotor for universal wood waste and pallets shredder". In addition, our shredder was registered as a model on the European market – under no. 002165837-0001 and our pre-shredder under no. 004754786. We also obtained a patent for special knives for pre-shredder P-201800051.

PLUG & PLAY

An intelligent control system enables completely automatic operation of the Robust Universal shredder and its simple upgrades to the highly productive lines that allow efficient processing and use of diverse materials, waste and scrap.

UP TO 48 MONTHS WARRANTY AND SERVICE

All ROBUST shredders are made at our registered place of business in Arja vas, and have up to 48 months warranty. We provide all services, necessary spare parts and additional equipment for our ROBUST shredders on the territory of European Union and wider.

HIGH QUALITY

Vital parts of THE shredder are made from high performance material such as HARDOX.

EASY MAINTENANCE

All vital parts of the Robust shredder are completely protected with easily removable lids that enable quick and easy access.

SAFETY AND RELIABILITY

The ROBUST Shredders are constructed in accordance with EU standards and meet all safety and health requirements of Directive 2006/42/EC, the Machinery Safety Rules (Official Gazette of the Republic of Slovenia, No. 75/08), Directive 73/23/EEC and the Rules on electrical equipment designed for use within certain voltage limits (Official Gazette of the Republic of Slovenia, No. 27/04). They are known for their safety at work. Since we provide complete final control of each shredder, we ensure their reliability; also, each crusher is set to optimal functional and safe operation.

ROBUST



ROBUST d.o.o.

Arja vas 105
3301 Petrovče, Slovenija

T: +386 (0)3 703 87 96, (0)3 703 88 30

M: +386 (0)51 317 141, (0)31 312 337

info@robust.si

www.robust.si

www.drobilnik.si



Robust shredders



POWER OF SHREDDING



THE MONSTER P150 TWIN POWER





ROBUST

ONE SHAFT SHREDDERS SD SERIES

THE ADVANTAGES FOR YOU

Universal use (diverse wood, pallets with nails and pins, particle boards, waste and scraps, veneer, MDF plates, cardboard boxes, plastics, textile etc.);

- Completely automatic operation
- Quiet and compact reduction gear with an extended service life*
- The engine start-up is controlled by the star/triangle system
- The entire hydraulic system is protected in the crusher housing (SD* and MONSTER series)
- The hardened knives with four cutting edges with an extended service life
- The crushing unit without any mechanical obstacles that could cause stopping
- The HARDOX sieve
- Simple installation, plug-in and start-up
- Economic use of energy
- Extremely quiet operation
- Simple and minimum maintenance

* except SD45



ROBUST SD 45

THE ADVANTAGES FOR YOU

The model SD 45 is characterized by a low power connectivity, high productivity, ease to use with a long warranty period (up to 4 years).

- Universal use (diverse wood, particle boards, veneer, MDF plates, cardboard boxes, plastics, etc.);
- Completely automatic operation
- The engine start-up is controlled by the star/triangle system
- The hardened knives with four cutting edges with an extended service life
- The crushing unit without any mechanical obstacles that could cause stopping
- The HARDOX sieve
- Simple installation, plug-in and start-up
- Economic use of energy
- Extremely quiet operation
- Simple and minimum maintenance

BASIC CHARACTERISTICS

POWER (kW)	11-15
ROTOR Ø (mm)	160
ROTOR SPEED (rpm)	140
NR. OF KNIVES (pcs.)	15
CHARGING HOLE (mm)	620 x 430
EXTRACTION CONNECTOR Ø	152
REQUIERED EXTRACTION SPEED	20
WEIGHT (kg)	920
SIEVE HOLE DIAMETER (mm)	10-50
PRODUCTIVITY** (cbm)	Appr. 0,5-1,5

** Depending on the material and diameter of openings in the sieve

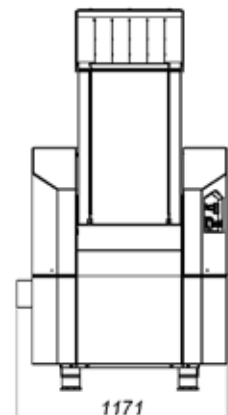
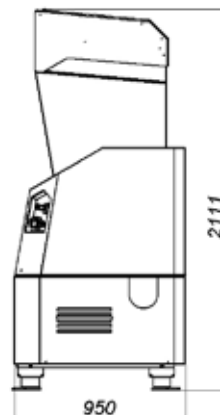



ROBUST SD 60

THE ADVANTAGES FOR YOU

- BOVER_BASIC intelligent control system
- Power set (electric motor, reduction gear and belt transmission)
- Filling hopper
- Hydraulic pressure unit
- Robust and adjustable
- Hardened knives with four cutting edges with an extended service life
- Hardened cleaning knives
- Hardened cutting racks
- HARDOX sieve
- The engine start-up is controlled by the star/triangle system

BASIC CHARACTERISTICS

POWER (kW):	15 / 18,5 / 22
FILLING HOLE (mm):	1445 × 1345
ROTOR WORKING LENGTH (mm):	650
ROTOR DIAMETER (mm):	270
NR. OF KNIVES (pcs):	28
SIEVE HOLE DIAMETER (mm):	10-50
PRODUCTIVITY (m³):	3 - 5*
WEIGHT(kg):	1750

* Depending on the material and diameter of openings in the sieve

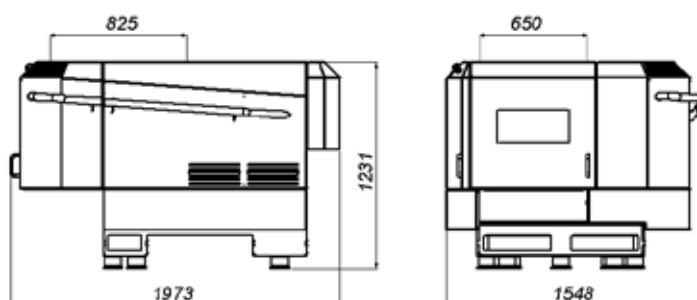

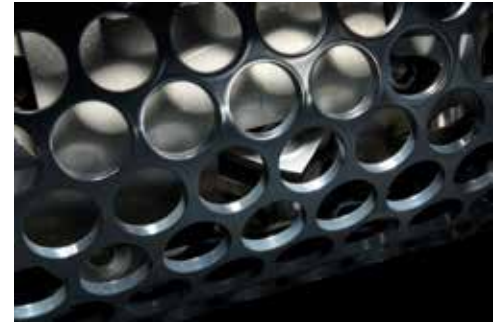

ROBUST SD 90

THE ADVANTAGES FOR YOU

- BOVER_BASIC intelligent control system
- Power set (electric motor, reduction gear and belt transmission)
- Filling hopper
- Hydraulic pressure unit
- Robust and adjustable
- Hardened knives with four cutting edges with an extended service life
- Hardened cleaning knives
- Hardened cutting racks
- HARDOX sieve
- The engine start-up is controlled by the star/triangle system
- **UPGRADE to BOVER PREMIUM intelligent control system***
- **UPGRADE with BIGGER FILLING HOPPER***
- **UPGRADE with PRE-SHREDDER P100 or P130***

*optional

BASIC CHARACTERISTICS

POWER (kW):	18,5 / 22
FILLING HOLE (mm):	1445 x 1565
ROTOR WORKING LENGTH (mm):	870
ROTOR DIAMETER (mm):	270
NR. OF KNIVES (pcs):	38
SIEVE HOLE DIAMETER (mm):	10-50
PRODUCTIVITY (m ³):	4 - 7*
WEIGHT(kg):	2050 / 3200**

* Depending on the material and diameter of openings in the sieve

** SD90 + interface + P130 with a hopper

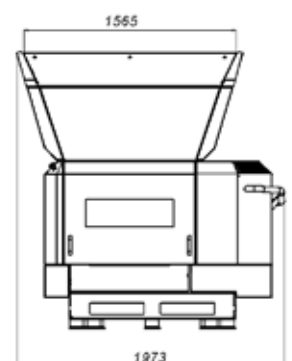
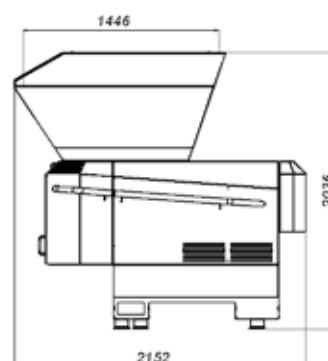
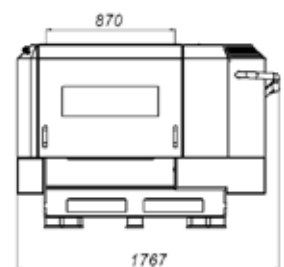
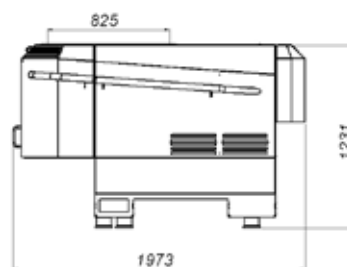



ROBUST SD 90 XL

THE ADVANTAGES FOR YOU

- BOVER_BASIC intelligent control system
- Power set (electric motor, reduction gear and belt transmission)
- Filling hopper
- Hydraulic pressure unit
- Robust and adjustable
- Hardened knives with four cutting edges with an extended service life
- Hardened cleaning knives
- Hardened cutting racks
- HARDOX sieve
- The engine start-up is controlled by the star/triangle system
- SPS wheeled cabinet + TOUCH SCREEN
- **UPGRADE to BOVER PREMIUM intelligent control system***
- **UPGRADE with BIGGER FILLING HOPPER***
- **UPGRADE with PRE-SHREDDER P150***

*optional

BASIC CHARACTERISTICS

POWER (kW):	18,5 / 22 / 30
FILLING HOLE (mm):	2030 × 1565
ROTOR WORKING LENGTH (mm):	870
ROTOR DIAMETER (mm):	270
NR. OF KNIVES (pcs):	38
SIEVE HOLE DIAMETER (mm):	10-50
PRODUCTIVITY (m ³):	5 - 8*
WEIGHT(kg):	2450 / 4200**

* Depending on the material and diameter of openings in the sieve

** R90XL + interface + P150 with a hopper

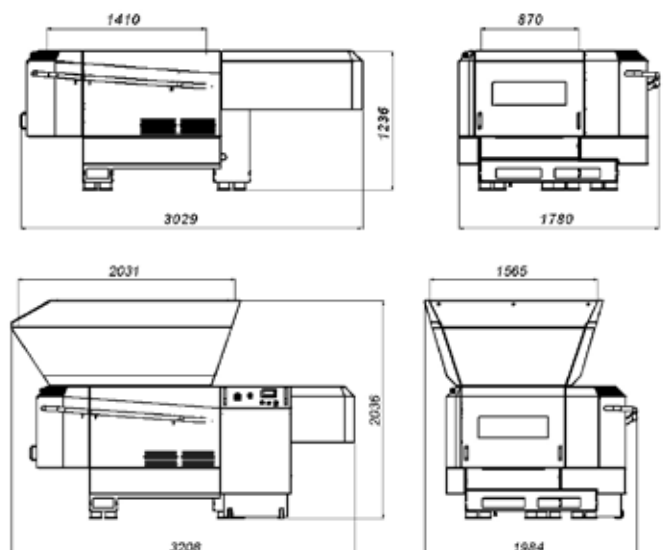

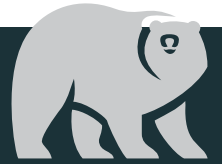

MONSTER SERIES

(first hybrid shredding machine)

The **MONSTER** is a hybrid machine with two shaft PRE-SHREDDER series P100, P130, P150 (one or two reduction gear) combine with one shaft SHREDDER series SD90 or SD90XL for efficient shredding of various types of pallets, styroform, plastic, waste, scrap and electrical devices.



MONSTER SERIES COMBINATION

Model + Engine power

The MONSTER 100 (SD90/18+P100/5,5KW)

The MONSTER 130 (SD90/22+P130/5,5KW)

The MONSTER 150 (SD90XL/22+P150/5,5KW)

The MONSTER 150 TWIN (SD90XL/22+P150/2x5,5KW)



EASY MAINTAINANCE



THE MONSTER 150 TWIN POWER

TECHNICAL FEATURES of THE MONSTER

SHAFT LENGHT (cm):	100/130/150
SHAFT RPM:	6+95
ELECTRIFICATION SECURITY:	32A-80A
CAPACITY:	up to 90 pallets/hour
MATERIALS:	pallets, styrofoam, electronic devices, car bumpers, all type of wood
DIMENSIONS (mm):	1000×800, 1300×800, 1500×800
GRANULATION (mm):	8-50
TECHNOLOGY:	HYBRID (two shaft + one shaft)
POWER (kW):	22-42
WEIGHT (kg):	4200

SERIAL: Secondary cutting blade- HARDOX , "TURBO" hydraulic agregate, pusher rack

OPTIONAL: Personalized hopper

ADDITIONAL WARRANTY: +1 year / 2000 w.h.

KEY FACTS

- Shredding capacity up to 90 palets/hour
- Easy maintainance
- Low operation cost
- High productivity



ADDITIONAL EQUIPMENT

SD 60	SD 90	SD 90XL	MONSTER
Secondary cutting HARDOX blade	Secondary cutting HARDOX blade	Secondary cutting HARDOX blade	Secondary cutting HARDOX blade - serial
Ajustible sieve rails	Ajustible sieve rails	Ajustible sieve rails	Ajustible sieve rails
Pusher rack	Pusher rack	Pusher rack	Pusher rack-serial
Suction sink	Suction sink	Suction sink	Suction sink
Snail conveyor	Snail conveyor	Snail conveyor	Snail conveyor
"TURBO" hydraulic agregate	"TURBO" hydraulic agregate	"TURBO" hydraulic agregate	"TURBO" hydraulic agregate - serial
Personalized hopper	Personalized hopper	Personalized hopper	Personalized hopper
SPS control system	SPS control system	SPS control system	SPS control system
Bover Standard	Bover Standard	Bover Standard	Bover Standard
Bovar Premium	Bovar Premium	Bovar Premium	Bovar Premium
Wearing parts	Wearing parts	Wearing parts	Wearing parts
Hardended cutting knives KIT (28 pcs)	Hardended cutting knives KIT (38 pcs)	Hardended cutting knives KIT (38 pcs)	Hardended cutting knives KIT (38 pcs)
Hardended cleaning knives KIT (4 pcs)	Hardended cleaning knives KIT (4 pcs)	Hardended cleaning knives KIT (4 pcs)	Hardended cleaning knives KIT (4 pcs)
Cutting blade KIT	Cutting blade KIT	Cutting blade KIT	Cutting blade KIT
Siev/screen	Siev/screen	Siev/screen	Siev/screen
Hydraulic oil 20L	Hydraulic oil 20L	Hydraulic oil 20L	Hydraulic oil 20L
Grease Lagermeister 400g	Grease Lagermeister 400g	Grease Lagermeister 400g	Grease Lagermeister 400g
Warranty extension + 1 year	Warranty extension + 1 year	Warranty extension + 1 year	Warranty extension + 1 year
Extra Features	Extra features	Extra features	Extra features
Heavy duty GEARBOX	Heavy duty GEARBOX	Heavy duty GEARBOX	Heavy duty GEARBOX

SNAIL CONVEYORS



KNIVES

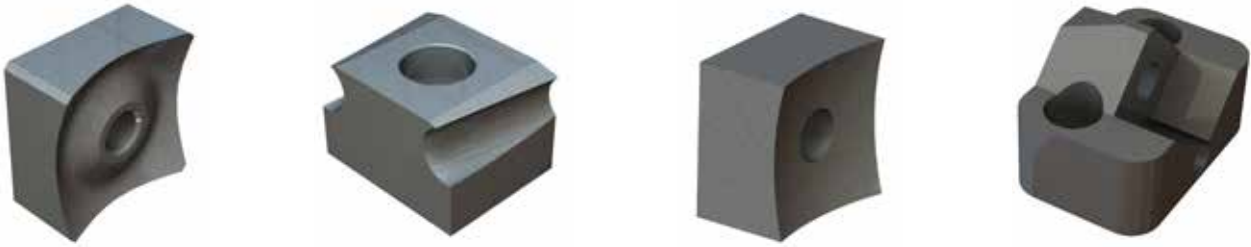

SIEVES / SCREENS



ROTOR and HOPPERS

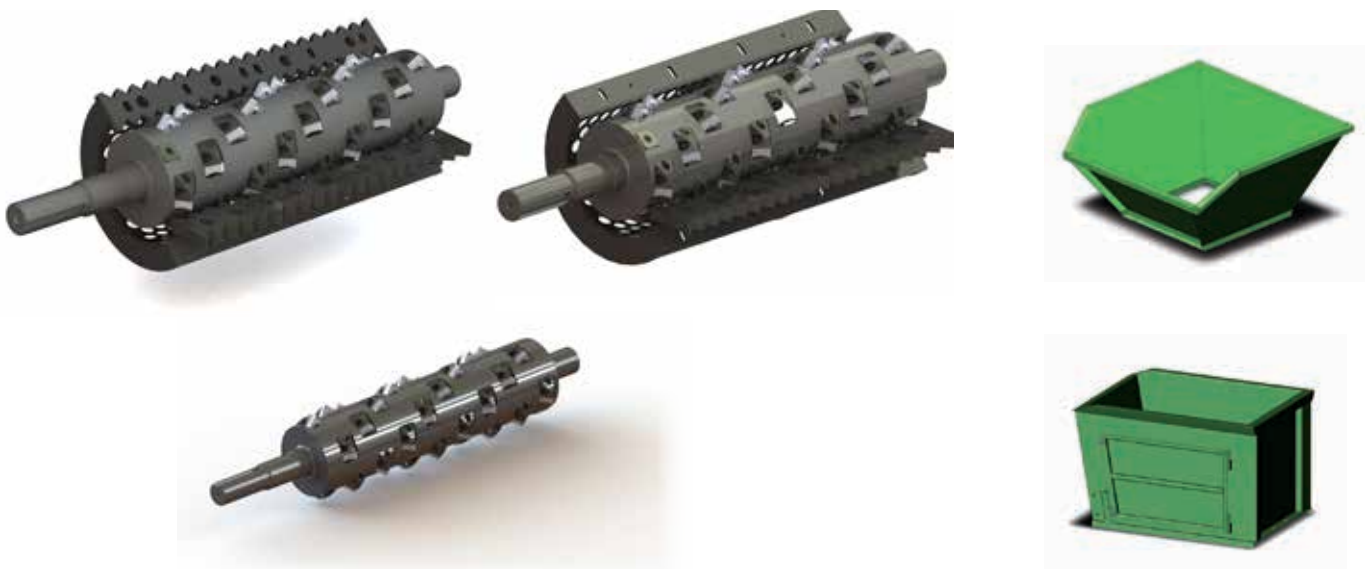

P-SERIES (PRE-SHREDDERS)

P series pre-shredders with high quality cutters and low rotation speed for a lower energy consumption and maximum productivity. Perfect shape and design for shredding wood pallets, plastic, Styrofoam or similar materials, that have a lot of empty spaces.



ROBUST P 100

THE ADVANTAGES FOR YOU

- High capacity
- Independent drive
- Freestanding or combine with Shredder (SD 90)
- Low operating costs

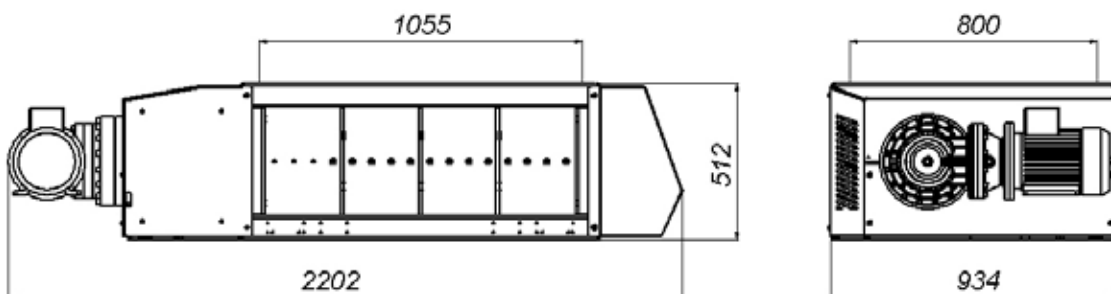

BASIC CHARACTERISTICS

POWER (kW):	5,5
FILLING HOLE (mm):	1055 x 800
ROTOR WORKING LENGTH (mm):	1075
ROTOR DIAMETER (mm):	430
CAPACITY (pcs/h):	50*
WEIGHT(kg):	1000** / 1350***

* Depending on the material and dimensions of pallets

** standing construction and filling hopper

*** For mounting on SD 90 with sliding flange or on self standing construction

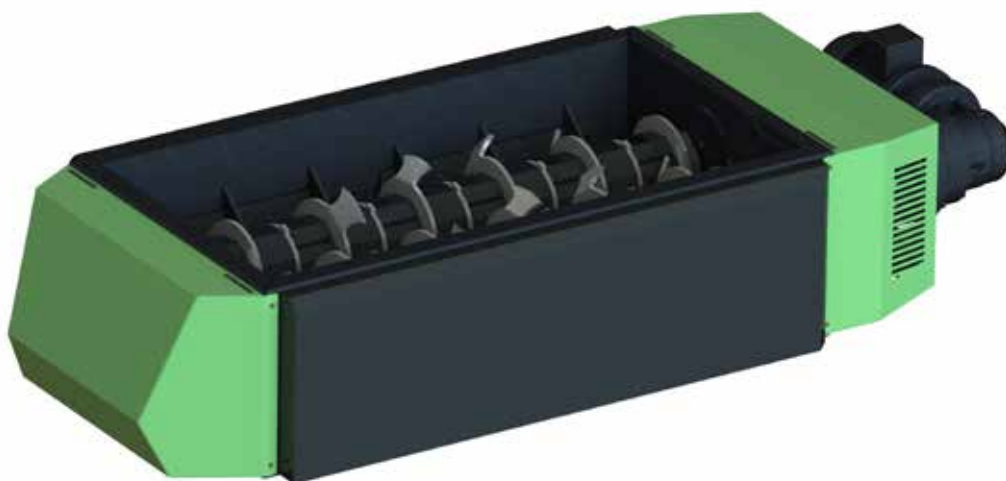

ROBUST P 130

THE ADVANTAGES FOR YOU

- High capacity
- Independent drive
- Freestanding or combine with Shredder (SD 90)
- Low operating costs

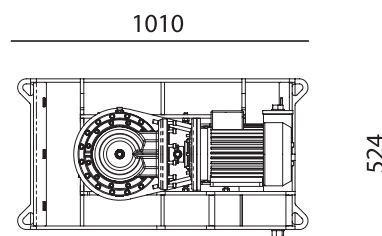
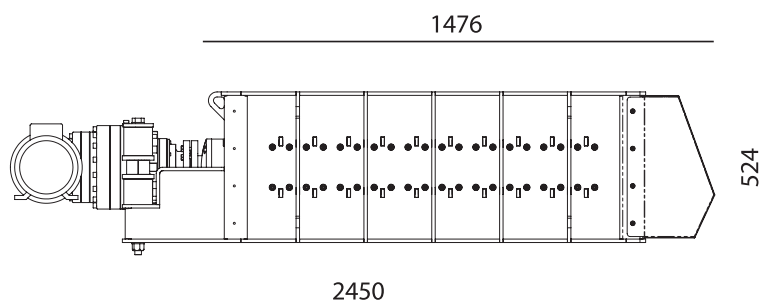

BASIC CHARACTERISTICS

POWER (kW):	4 - 7
FILLING HOLE (mm):	1300 x 800
ROTOR WORKING LENGTH (mm):	1300
ROTOR DIAMETER (mm):	430
CAPACITY (pcs/h):	50*
WEIGHT(kg):	1020

* Depending on the material and dimensions of pallets



ROBUST P 150

THE ADVANTAGES FOR YOU

- High capacity
- Independent drive
- Freestanding or combine with Shredder (SD 90XL)
- Low operating costs

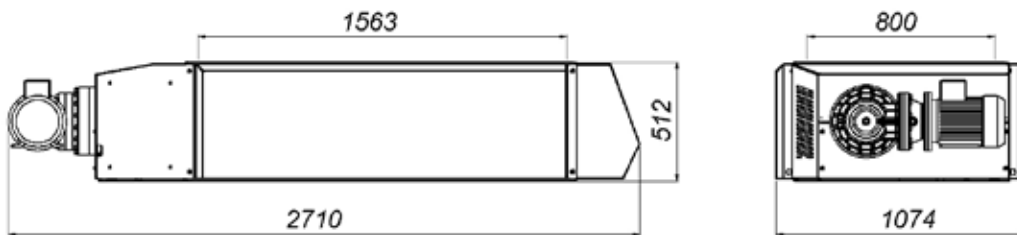

BASIC CHARACTERISTICS

POWER (kW):	5,5
FILLING HOLE (mm):	1560 x 800
ROTOR WORKING LENGTH (mm):	1580
ROTOR DIAMETER (mm):	430
CAPACITY (pcs/h):	60*
WEIGHT(kg):	1200** / 1640***

* Depending on the material and dimensions of pallets

** standing construction and filling hopper

*** For mounting on SD 90XL with sliding flange or on self standing construction





**FREE STANDING
CONSTRUCTION**

ROBUST P 150 TWIN POWER

THE ADVANTAGES FOR YOU

- High capacity
- Independent drive
- Freestanding or combine with Shredder (SD 90XL)
- Low operating costs

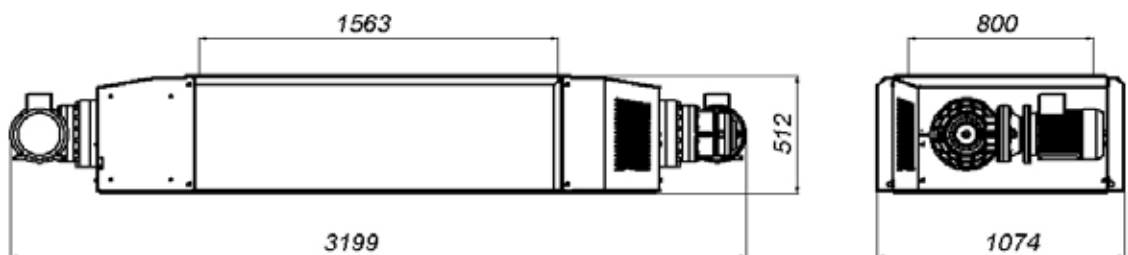

BASIC CHARACTERISTICS

POWER (kW):	2 x 5,5
FILLING HOLE (mm):	1560 x 800
ROTOR WORKING LENGTH (mm):	1580
ROTOR DIAMETER (mm):	430
CAPACITY (pcs/h):	80*
WEIGHT(kg):	1400** / 1840***

* Depending on the material and dimensions of pallets

** standing construction and filling hopper

*** For mounting on SD 90XL with sliding flange or on self standing construction



H-SERIES SHREDDER

The shredders H- series are used for shredding of very long and oversized wood waste, long boards and pallets. The material is put in to the rotor horizontally through roller feed, or vibrating channel feeder. Companies usually use it directly next to wood processing machines.

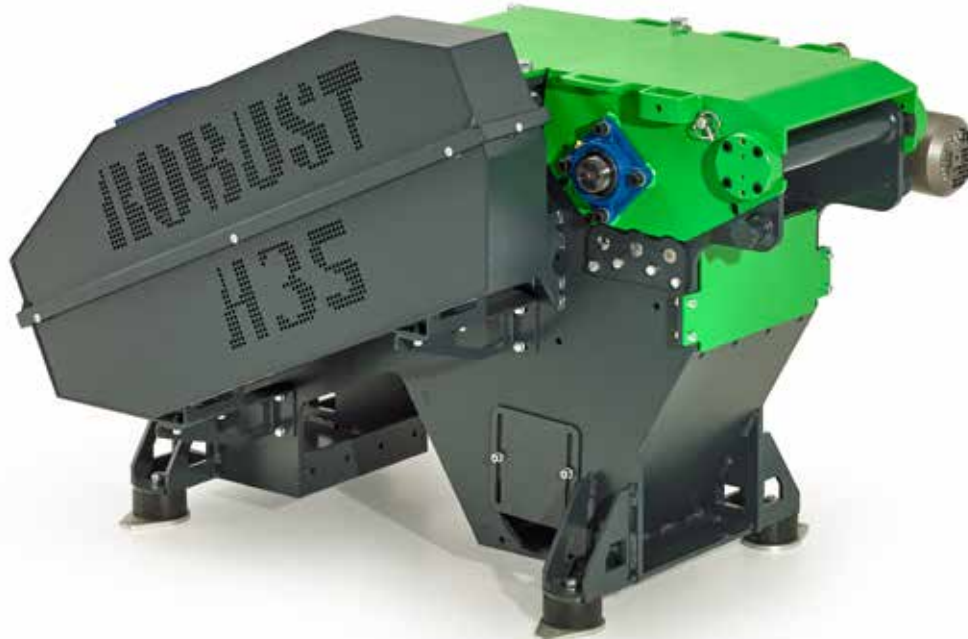

ROBUST H 35

THE ADVANTAGES FOR YOU

- High capacity
- Independent drive
- Freestanding or combine with a production line
- Low operating costs
- Wet and dry wood
- Soft and hard wood

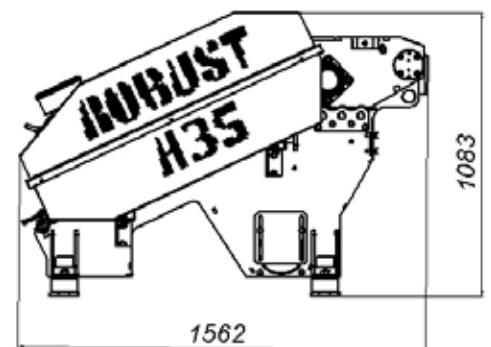

BASIC CHARACTERISTICS

POWER (kW):	15/18,5/22
FILLING HOLE (mm):	350 x 50
ROTOR WORKING LENGTH (mm):	350
ROTOR DIAMETER (mm):	260
SIEVE HOLE DIAMETER (mm):	7 - 30
PRODUCTIVITY (m ³ /h):	3-5*
WEIGHT(kg):	920

* Depending on the material and diameter of openings in the sieve

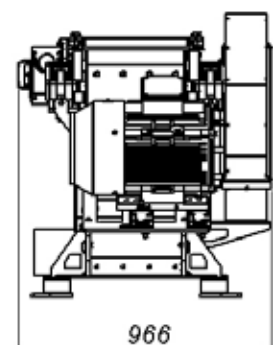

EXAMPLES OF MATERIALS AND GRANULES

The crushed material of the desired granulation comes through the openings in a sieve made of HARDOX without stopping.



KEY ELEMENTS

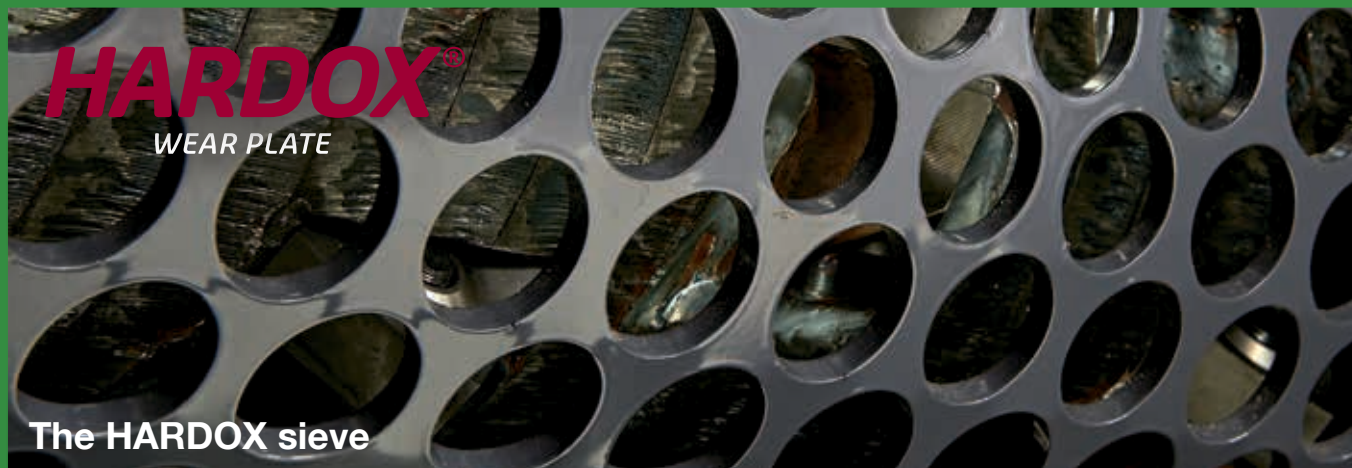



All our products are subject to constant development, therefore the technical specifications are not binding and may change. The pictures are of an illustrative nature and due to development changes and improvements they do not always represent the actual state.



ROBUST 

ROBUST d.o.o.
Arja vas 105
3301 Petrovče, Slovenia

T: +386 (0)3 703 87 96
M: +386 (0)51 317 141, (0)31 312 337

info@robust.si

www.robust.si
www.drobilnik.si



Robust shredders