

SEMI AUTOMATIC

# MYTHO

MAINTENANCE FREE MACHINES  
EASY TO BE INSTALLED

Atlanta Stretch S.p.A - Italy  
Atlanta Deutschland GmbH  
Atlanta Iberica - Spain  
Atlanta Packaging Ltd - UK  
Atlanta France Sarl  
Atlanta Stretch Australia  
Atlanta Stretch Russia



**ATLANTA**  
S T R E T C H

stretch wrapping machines specialist



[www.atlantastretch.com](http://www.atlantastretch.com)

**IT\_** Tavola rotante di nuova generazione per avvolgere carichi palletizzati di qualsiasi forma e peso con film estensibile anche macroforato.

**EN\_** New design turntable for wrapping palletised loads of any shape and weight with stretchable film, including macro-holed film.

**FR\_** Table tournante de dernière génération pour filmer les charges palettisées avec du film étirable plein ou macro perforé.

**DE\_** Stretchwickler der neuen Generation zum Wickeln von Ladungen unterschiedliche Formen und Gewichte mit Stretchfolien oder gelochte Stretchfolien.

**ES\_** Mesa rotante de nueva generación para envolver cargas paletizadas de cualquier forma y peso, con film extensible y macro perforado.

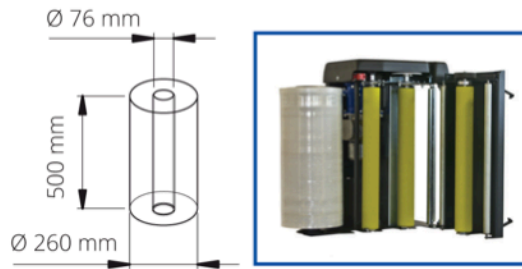

### Pallet dimension

- Ø 1500 max 800x1200 mm
- Ø 1650 max 1000x1200 mm
- Ø 1800 max 1200x1200 mm
- Ø 2200 max 1500x1500 mm
- Ø 2400 max 1650x1650 mm

**IT\_** Minimo ingombro, trasporto facile, costi di gestione ridotti.

**EN\_** Small footprint, easy transport, reduced operating costs.

**FR\_** Faible encombrement, transport facile, coûts d'exploitation réduits.

**DE\_** Geringer Platzbedarf, einfachen Transport, Senkung der Betriebskosten.

**ES\_** Ocupa poco espacio, fácil transporte, reducción de los costos de operación



## MYTHO TP

**IT\_** Versione transpallet.

**EN\_** Transpallet version.

**FR\_** Version transpalette.

**DE\_** Ausführung Transpallet.

**ES\_** Version transpalet.

**Pallet**  
Max weight 1200 kg

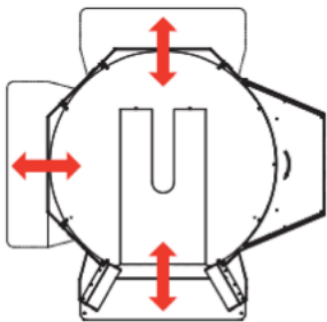

## MYTHO / MYTHO EASY

**IT\_** Con Mytho / Mytho-Easy (facile da usare), si completa la gamma di macchine, questa versione si caratterizza per le funzioni semplificate. Pannello di controllo multifunzione programmabile.

**EN\_** The easy-to-use Mytho-Easy completes our range of machines; this version features simplified operation. Multifunction programmable control panel.

**FR\_** Mytho-Easy (utilisation facile) se caractérise pour l'utilisation et l'application de film pré-étiré et par ses fonctions simples mais complètes. Panneau de contrôle multifonction programmable.

**DE\_** Mytho-Easy (Einfach zum Bedienen) ergänzt die Baureihe der Stretchwickler, das Merkmal dieses Modell ist die Vereinfachung der Funktionen. Multifunktion programmierbare Systemsteuerung.

**ES\_** Con Mytho-Easy (facil da usar), se completa la gama de maquinas, esta versión se caracteriza por las funciones simplificadas. Panel de control programable multifunción.



**Display touch-screen 11"**  
easy to use  
(version Mytho / Mytho Easy)

**Pallet**  
Max weight 2000 kg



**FM**

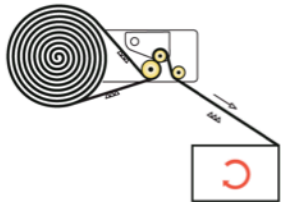

**IT\_** Freno meccanico regolabile manualmente

**EN\_** Mechanical brake manually adjustable.

**FR\_** Frein mécanique sur rouleau de détour ajustable manuellement.

**DE\_** Mechanische Bremse auf Umlenkwalze.

**ES\_** Fricción mecánica regulable manualmente.

**FE**



**IT\_** Frizione elettromagnetica regolabile da pannello comandi.

**EN\_** Electromagnetic friction adjustable from control panel.

**FR\_** Frein électromagnétique réglable depuis le panneau de commande.

**DE\_** Elektromagnetische Bremse auf Umlenkwalze vom Bedienpult einstellbar.

**ES\_** Fricción electromagnética regulable desde el panel de comandos.

**PRS POWER ROLLER STRETCH**

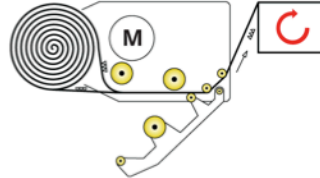

**IT\_** Sistema di prestiro motorizzato a 3 rulli comandato elettronicamente con rapporti intercambiabili: 150 - 200 - 250%.

**EN\_** Motorized pre-stretch system with 3 driven rollers electronically controlled with interchangeable ratios: 150 - 200 - 250%.

**FR\_** Système de pré-étirage motorisé et asservi à 3 rouleaux, rapports interchangeables: 150 - 200 - 250%.

**DE\_** Angetriebener Vordehnssystem mit 3 Vordehnrollen, elektronisch gesteuert mit leicht wechselbarer Zahnradsätzen: 150 - 200 - 250%.

**ES\_** Sistema de prestiro motorizado con 3 rodillos, comandado electrónicamente con desarrollos intercambiables: 150 - 200 - 250%.

**PS POWER STRETCH**

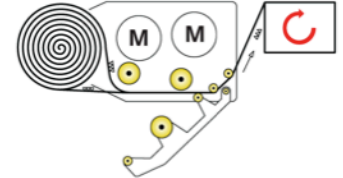

**IT\_** Sistema di prestiro motorizzato a 3 rulli con 2 motori e variazione continua da 120 a 350% regolabile da quadro comandi.

**EN\_** Motorized pre-stretch system with 3 driven rollers and 2 motors adjustable between 120 to 350% from control panel.

**FR\_** Système de pré-étirage motorisé et asservi à 3 rouleaux et 2 moteurs, rapport ajustable de 120 à 350% depuis le panneau de commande.

**DE\_** Angetriebener Vordehnssystem mit 3 Vordehnrollen und 2 Motoren, stufenlos regelbare Werte zwischen 120 und 350% von Bedienpult.

**ES\_** Sistema de prestiro motorizado con 3 rodillos y 2 motores, regulable da 120 a 350% desde el panel de comandos.

## MYTHO / MYTHO EASY / MYTHO TP

### TECHNICAL CHARACTERISTICS

Total installed power	1.75 Kw
Standard input voltage	230V mono-phase - 50/60 Hz
Electrical system and motors protection	IP 54
Standard pallet height	2400 mm (with Mast 2500 mm)
Optional pallet height	3000 mm / 3300 mm / 3700 mm
Max loading weight	2000 Kg ( <b>TP</b> 1200 Kg )
Table diameter	1650 mm / 1800 mm / 2200 mm / 2400 mm



## OPTIONAL



- IT\_ Pressore tenuta pallet.
- EN\_ Pallet holder presser.
- FR\_ Plateau stabilisateur de charge.
- DE\_ Palettendruckhalter.
- ES\_ Prensor retención palet.

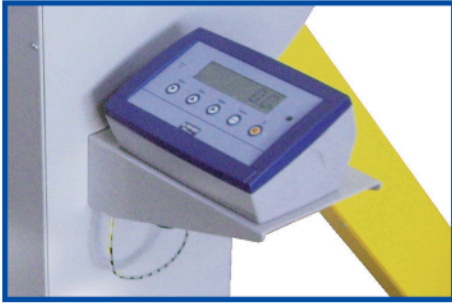

- IT\_ Sistema di pesatura integrato.
- EN\_ Integrated weighing systems.
- FR\_ Pesage intégré.
- DE\_ Integrierte Waagesysteme.
- ES\_ Sistema integrado de pesaje.



- IT\_ Sistema d'imballo per porte e finestre.
- EN\_ Wrapping System for doors and windows.
- FR\_ Système d'emballage pour portes et fenêtres.
- DE\_ Wickelsysteme für Fenster und Türen.
- ES\_ Sistema de embalaje para puertas y ventanas.



- IT\_ Colonna per carichi fino a 3700 mm.
- EN\_ Mast for loads up to 3700 mm high.
- FR\_ Colonne pour charges jusqu'à 3700 mm.
- DE\_ Mast für Ladungen bis 3700 mm hoch.
- ES\_ Columna para cargas de hasta 3700 mm.



- IT\_ Controllo peso film.
- EN\_ Film weight check.
- FR\_ Calcul poids de film.
- DE\_ Kontrolle Foliengewicht.
- ES\_ Control peso film.

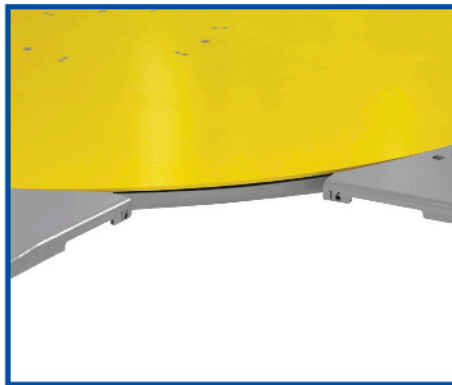

- IT\_ Basamento basso profilo per transpallet manuale.
- EN\_ Low profile basement for manual lifter.
- FR\_ Châssis extra fin pour transpalette manuel.
- DE\_ Flaches Drehtellergestell für Handhubwagen.
- ES\_ Base con perfil bajo especial para transpaletas.

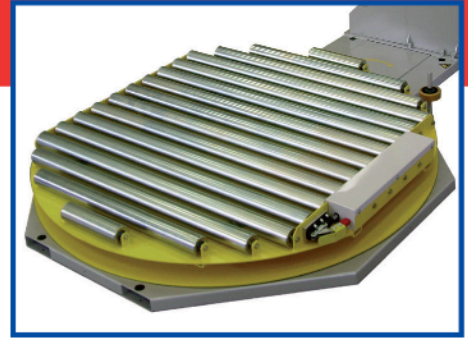

- IT\_ Rulliera non motorizzata.
- EN\_ Non-motorized roller conveyor.
- FR\_ Non-motorisés à rouleaux.
- DE\_ Nicht-Motorisierte Rollenbahn.
- ES\_ Rodillos no motorizados.



- IT\_ Rampa di carico.
- EN\_ Loading ramp.
- FR\_ Rampe.
- DE\_ Ladungsrampe.
- ES\_ Rampa de carga.

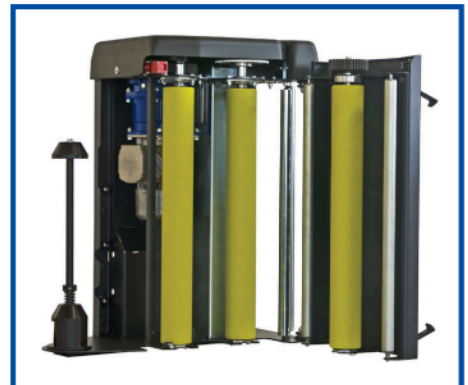

- IT\_ Inserisco il film estensibile con facilità e ne consumo poco. Sistema di taglio automatico del film a fine ciclo.
- EN\_ I easily insert stretch film and I use it economically. Automatic Film cutting device at cycle end.
- FR\_ Facilité de passage du film en sécurité et consommation réduite. Coupe automatique du film.
- DE\_ Schnelle Einführungs-system und sparsame Verbrauch von Stretchfolien. Automatische Folienschneidvorrichtung am Zyklusende.
- ES\_ Introducción del film extensible con facilidad y reducido tiempo. Sistema automático de corte film con fin de ciclo.

**Atlanta Stretch S.p.A.**  
 Via Chiesa di Camerano, 30  
 47824 Poggio Torriana (Rimini) Italia  
 Tel. +39 0541 627145  
 Fax +39 0541 627220  
 www.atlantastretch.com  
 sales@atlantastretch.com

**ATLANTA**  
**S T R E T C H**  
 stretch wrapping machines specialist