



Leica DM6000 B Leica DM6000 M

Operating Manual

Leica
MICROSYSTEMS

Published January 2004 by:

Leica Microsystems Wetzlar GmbH
Ernst-Leitz-Straße
D-35578 Wetzlar (Germany)

Responsible for contents:

Karin Schwab
(Marketing CM, Compound Microscopy, Product Management)

Holger Grasse

(Safety Officer according to MPG §30)

In case of questions, please contact the hotline:

Phone +49(0)6441-292286

Fax +49(0)6441-292255

E-mail: MQM-Hotline@leica-microsystems.com



Leica DM6000 B Leica DM6000 M

Operating Manual

Leica
MICROSYSTEMS

Copyrights

All rights to this documentation are held by Leica Microsystems Wetzlar GmbH. Reproduction of text or illustrations (in whole or in part) by print, photocopy, microfilm or other method (including electronic systems) is not allowed without express written permission from Leica Microsystems Wetzlar GmbH.

The term "Windows" can be used in the following text without further identification. It is a registered trademark of the Microsoft Corporation. Otherwise, no inference with regard to the free usability of product names may be drawn from the use of those names.

The instructions contained in the following documentation reflect state-of-the-art technology and knowledge standards. We have compiled the texts and illustrations as accurately as possible. Nevertheless, no liability of any kind may be assumed for the accuracy of this manual's contents. Still, we are always grateful for comments and suggestions regarding potential mistakes within this documentation.

The information in this manual is subject to modification at any time and without notification.

Contents

1. Important Notes about this Manual	7	7. Startup	38
2. Intended Purpose of Microscopes	8	7.1 Functional Principle	38
3. Safety Notes	9	7.2 Switching on	43
3.1 General Safety Notes	9	7.3 The LeicaScreen	44
3.2 Electrical Safety	10	7.4 The Function Keys at the Stand	45
4. Overview of the Instrument	12	7.5 The Remote Control Element SmartMove	46
5. Unpacking the Microscope	18	7.6 Köhler Illumination	46
6. Assembling the Microscope	20	7.6.1 Transmitted Light	46
6.1 Stage	21	7.6.2 Incident Light	48
6.2 Condenser	22	7.7 Checking Phase Contrast Rings	49
6.3 Tube and Eyepieces	23	7.8 Adjusting the motorized Polarizer	51
6.4 Objectives	24	7.9 Adjusting the Light Sources	51
6.5 Light Sources for the Transmitted Light Axis	24	8. Operation	57
6.6 Light Sources for the Incident Light Axis	26	8.1 Switching on	57
6.7 Equipping the Incident Light Turret Disc	31	8.2 Stages and Specimen Displacement ...	59
6.8 Polarizer and Analyzer	32	8.3 Focusing	60
6.9 DIC Prisms	33	8.4 Tubes	61
6.10 Optional Accessories	34	8.5 Eyepieces	63
6.11 Connecting the Leica CTR6000 Electronics Box	36	8.6 Objectives	63
6.12 Connecting the Computer	37	8.7 Magnification Changer	66
6.13 Connection to the Power Supply	37	8.8 Light Sources	66
		8.9 Aperture Diaphragm and Field Diaphragm	67

9. Contrasting Methods for Leica DM6000 B	68	11. Trouble Shooting	78
9.1 Transmitted Light	68	12. Care of the Microscope	81
9.1.1 Bright Field	68	12.1 Dust Cover	81
9.1.2 Phase Contrast	69	12.2 Cleaning	81
9.1.3 Dark Field	69	12.3 Handling Acids and Bases	82
9.1.4 Polarization	70	13. Essential Wear and Spare Parts	83
9.1.5 Differential Interference Contrast.....	71	14. Abbreviations and Pictograms	84
9.2 Fluorescence	72	15. Index	86
9.3 Combi Mode	73	16. EU Declaration of Conformity	87
10. Contrasting Methods for Leica DM6000 M	74		
10.1 Incident Light	74		
10.1.1 Bright Field	74		
10.1.2 Dark Field	74		
10.1.3 Polarization	75		
10.1.4 Interference Contrast.....	76		
10.1.5 Fluorescence	76		
10.2 Transmitted Light	77		
10.2.1 Bright Field	77		
10.2.2 Polarization	77		

1. Important Notes about this Manual



Caution!

This operating manual is an essential component of the microscope, and must be read carefully before the microscope is assembled, put into operation or used.

This operating manual contains important instructions and information for the operational safety and maintenance of the microscope and accessories. Therefore, it must be kept and taken care of.

For the operation of the LeicaScreen and the Software Leica DMControl, please see separate operating manual.

Text symbols, pictograms and their meanings:

(1.2)

Numbers in parentheses, such as "(1.2)", correspond to illustrations (in the example, Figure 1, Item 2).

→ p.20

Numbers with pointer arrows (for example → p.20), point to a certain page of this manual.



Caution!

Special safety instructions within this manual are indicated with the triangle symbol shown here, and have a gray background.



Caution! The microscope and accessories can be damaged when operated incorrectly.



Explanatory note.

*

Item not contained in all configurations.

2. Intended Purpose of Microscopes

The Leica DM6000 B microscope, to which this user manual belongs, is designed for biological routine and research applications. This includes the examination of samples taken from the human body with a view to providing information on physiological or pathological states or congenital abnormalities, or to determining the safety and compatibility with potential recipients, or to monitoring therapeutic measures.

The Leica DM6000 M microscope is designed for examinations in the field of materials research.

All the above-named microscopes comply with the Council Directive 98/79/EEC concerning in vitro diagnostics. They also conform to the Council Directives 73/23/EEC concerning electrical apparatus and 89/336/EEC concerning electromagnetic compatibility for use in an industrial environment.



Caution!

The manufacturer assumes no liability for damage caused by, or any risks arising from using the microscopes for other purposes than those for which they are intended or not using them within the specifications of Leica Microsystems Wetzlar GmbH. In such cases the conformity declaration shall cease to be valid.



Caution!

These (IVD) devices are not intended for use in the patient environment defined by DIN VDE 0100-710. Neither are they intended for combining with medical devices according to EN 60601-1. If a microscope is electrically connected to a medical device according to EN 60601-1, the requirements defined in EN 60601-1-1 shall apply.

3. Safety Notes

3.1 General Safety Notes

This safety class 1 device is constructed and tested in accordance with EN 61010-2-101:2002, EN 61010-1:2001, IEC 1010-1:2001, safety regulations for electrical measuring, control, and laboratory devices.



Caution!

In order to maintain this condition and to ensure safe operation, the user must follow the instructions and warnings contained in this operating manual.



Caution!

The devices and accessories described in this operating manual have been tested for safety and potential hazards.

The responsible Leica affiliate or the main plant in Wetzlar must be consulted whenever the device is altered, modified or used in conjunction with non-Leica components that are outside of the scope of this manual.

Unauthorized alterations to the device or noncompliant use shall void all rights to any warranty claims!

3. Safety Notes

3.2 Electrical Safety

General specifications

Leica CTR6000 electronics box

For indoor use only.

Supply voltage:	90-250 V~
Frequency:	50-60 Hz
Power input:	max. 290 VA
Fuses:	T6,3 A (IEC 60127-2/3)
Ambient temperature:	15-35°C
Relative humidity:	max. 80% to 30°C
Overvoltage category:	II
Pollution degree:	2

Microscope

For indoor use only.

Supply voltage:	90-250 V~
Frequency:	50-60 Hz
Power input:	See CTR6000
Fuses:	See CTR6000
Ambient temperature:	15-35°C
Relative humidity:	max. 80% to 30°C
Overvoltage category:	II
Pollution degree:	2

Supply unit ebq 100*

For indoor use only.

Supply voltage:	90-250 V~
Frequency:	50-60 Hz
Power input:	max. 155 VA
Fuses:	2xT2A (IEC 127)
Ambient temperature:	10-36°C
Relative humidity:	max. 80% to 30°C
Overvoltage category:	II
Pollution degree:	2

(see enclosed manual)



Caution!

The power plug may only be plugged into an outlet equipped with a grounding contact.

Do not interfere with the grounding function by using an extension cord without a ground wire. Any interruption of the ground wire inside or outside of the device, or release of the ground wire connection, can cause the device to become hazardous. Intentional ground interruption is not permitted!



Caution!

Through activating to the grounding connection (earth screw on the back of the Leica CTR6000 Electronics Box) ancillary equipment with its own and/or extra power supply may be brought to the same ground wire potential. For connections without a ground connector, Leica Service must be consulted.



Caution!

Never use any fuses as replacements other than those of the types and the current ratings listed here. Using patched fuses or bridging the fuse holder is not permitted.



Caution!

The microscope's electrical accessory components are not protected against water. Water can cause electric shock.



Caution!

Protect the microscope from excessive temperature fluctuations. Such fluctuations can lead to the accumulation of condensation, which can damage the electrical and optical components.
Ambient temperature: 15-35°C.



Caution!

Before exchanging the fuses or lamps, be absolutely certain to switch-off the main power switch and remove the power cable.

4. Overview of the Instrument

Specification	Leica DM6000 B	Leica DM6000 M
Contrasting Method	<ul style="list-style-type: none"> transmitted light: BF, DF, PH, ICT (DIC), Pol incident light: Fluo 	<ul style="list-style-type: none"> transmitted light: BF, Pol incident light: BF, DF, ICR (DIC), Pol, Fluo
Transmitted Light Axis	<ul style="list-style-type: none"> automatic Illumination Manager (automatic aperture diaphragm and field diaphragm, automatic intensity control) automatic Constant Color Intensity Control (CCIC) motorized shutter 	
Incident Light Axis	<ul style="list-style-type: none"> integrated into the stand motorized 8x filter turret (5x optional) with FIM (Fluorescence Intensity Manager) for decreasing light intensity in 5 steps mechanical "Booster Lens" for increasing fluorescence intensity Mechanical Excitation Manager to control the fluorescence emission when using double and triple filter cubes. motorized shutter (speed < 0.1 s) 	<ul style="list-style-type: none"> integrated into the stand motorized 4x filter turret (2 fixed positions, 2 variable positions) automatic Illumination Manager motorized shutter (speed < 0.1 s)
Tube	<ul style="list-style-type: none"> motorized or manual up to 3 beam splitting positions optionally with two camera outputs (for one digital and one analog camera) 	

Specification	Leica DM6000 B	Leica DM6000 M
Magnification Changer (optional)	<ul style="list-style-type: none"> • manual • absolute coded • magnification steps: 1x; 1.25x; 1.6x 	<ul style="list-style-type: none"> • manual • absolute coded • magnification steps: 1x; 1.5x; 2x
Objective Turret	<ul style="list-style-type: none"> • motorized • absolute coded • 7x for objectives with M25 thread • mot. DIC objective prism turret with 4 positions (optional) 	<ul style="list-style-type: none"> • motorized • absolute coded • 6x for objectives with M32 thread • mot. DIC objective prism turret with 4 positions (optional)
X/Y Stage	<ul style="list-style-type: none"> • motorized, direct stepper motor drive • replaceable specimen stage • zero position defined by end switch • outer dimensions: 234 mm x 157 mm • travel range: 76 mm x 50 mm • smallest increment: 0.3 μm 	
Condenser	<ul style="list-style-type: none"> • motorized condenser head • automatic change between contrasting methods: motorized condenser turret for light rings, DF stop, DIC prisms • optional polarizer integrated and motorized • automatic Köhler Illumination 	
Z Drive	<ul style="list-style-type: none"> • motorized • dovetail for exchanging stage • travel range: 25 mm • smallest increment: 0.015μm • max. speed: 5 mm/s • min. speed: 1 mm/s • max. load: 4 kg 	

4. Overview of the Instrument

Specification	Leica DM6000 B	Leica DM6000 M
Control Panels	<ul style="list-style-type: none"> • Function keys at the stand • additional variable function keys • focusing knobs • LeicaScreen: touch sensitive LC display 70mm x 70mm, monochromatic • SmartMove: ergonomic control element for x,y,z control with additional variable function keys 	
Leica CTR6000 Electronics Box	<ul style="list-style-type: none"> • separate control unit to control <ul style="list-style-type: none"> • z-drive • xy-stage • objective turret with: <ul style="list-style-type: none"> • supply voltage for 100W halogen lamp • supply voltage for SmartMove See → p.10 (electrical safety))	
Computer Interface	<ul style="list-style-type: none"> • RS232C 	
Software Tools	<ul style="list-style-type: none"> • Leica Application Suite with DMControl for Windows™ 2000, XP • with plug-ins for: <ul style="list-style-type: none"> • microscope and camera configuration • microscope and camera control • image acquisition 	

Fig. 1 System overview DM6000 B
with remote control element SmartMove
and electronic box Leica CTR6000



4. Overview of the Instrument

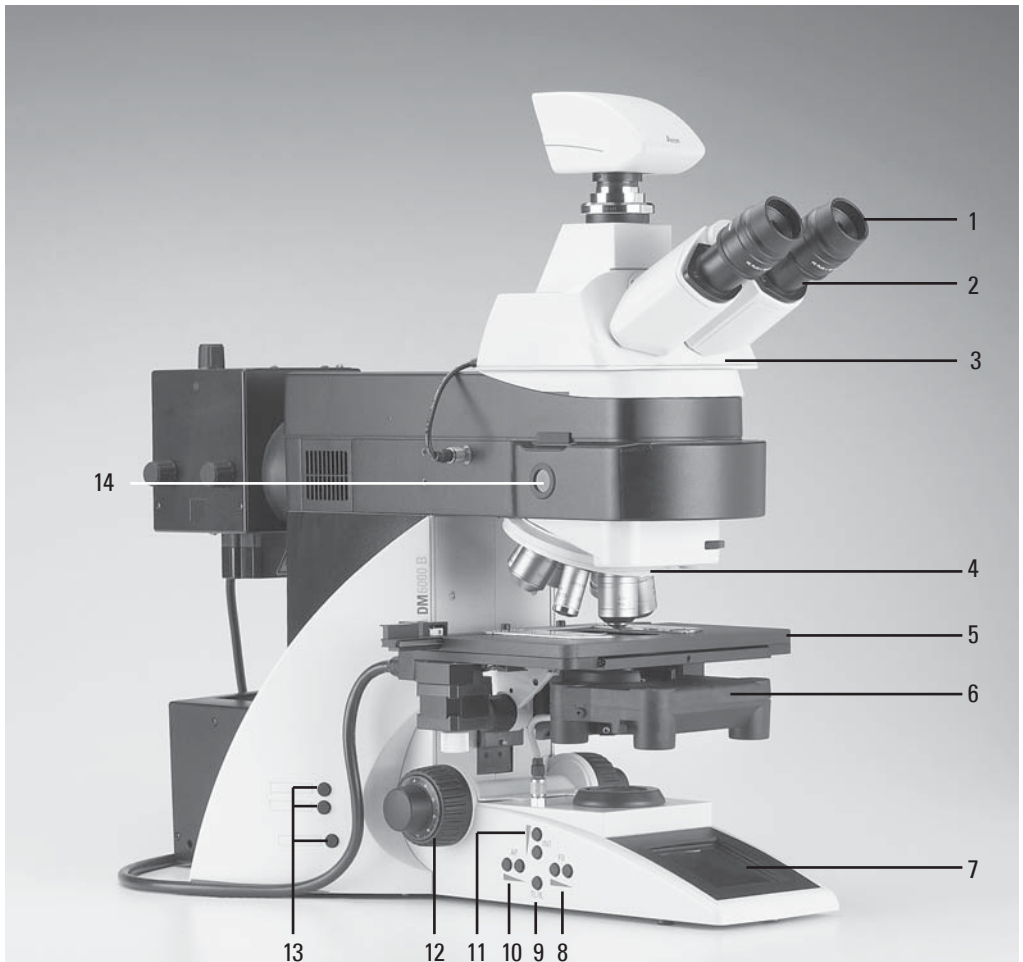

Fig. 2 Left side of the stand Leica DM6000 B

- | | | | |
|---|---|----|---|
| 1 | Eyepiece | 8 | Function keys field diaphragm |
| 2 | Eyepiece tube | 9 | Transmitted light/incident light switch |
| 3 | Motorized tube MBDT | 10 | Function keys aperture diaphragm |
| 4 | Motorized objective nosepiece with objectives | 11 | Function keys light intensity |
| 5 | Motorized specimen stage with specimen holder | 12 | Focus wheel |
| 6 | Condenser | 13 | Variable function keys (factory pre-assigned) |
| 7 | LeicaScreen | 14 | Lamp adjustment window |

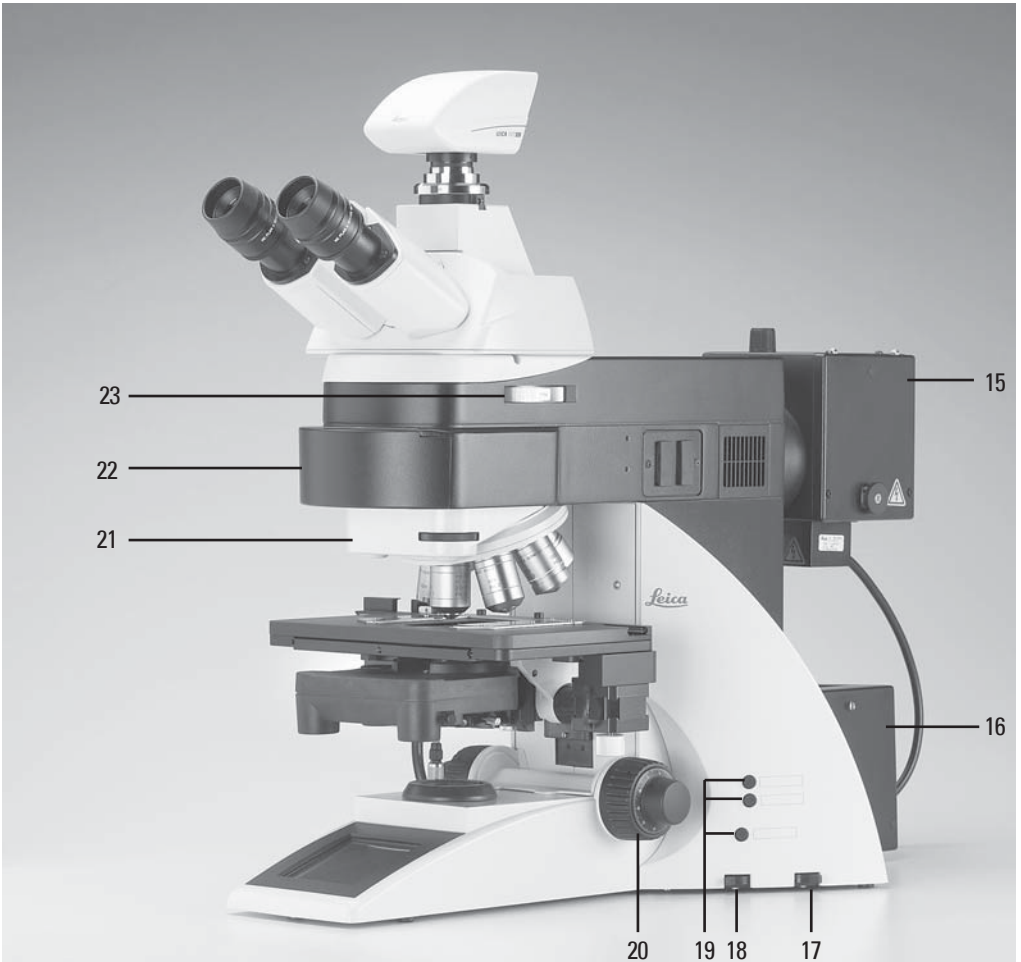
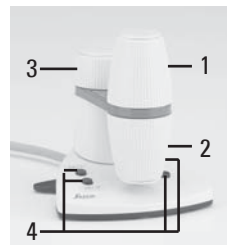

Fig. 3 Right side of the stand Leica DM6000 B

- 15 Lamp housing for incident light
- 16 Lamp housing for transmitted light
- 17 Transmitted light filter, optional
- 18 Transmitted light filter, optional
- 19 Variable function keys (factory pre-assigned)
- 20 Focus wheel
- 21 DIC turret
- 22 Motorized filter turret
- 23 Magnification changer

Fig. 4 Remote control element SmartMove

- 1 Movement (x-direction)
- 2 Movement (y-direction)
- 3 Focus adjustment
- 4 Variable function keys (factory pre-assigned)



5. Unpacking the Microscope

The device is delivered in several boxes.

The **stand box** contains the following components:

- Stand with integrated incident light axis and objective nosepiece
- Specimen stage with stage bracket
- Power cable and PC connecting cable
- CD with Leica DMControl software package
- Instructions and list of microscope default settings („Identification Sheet“)

The **system box** contains the microscope accessories:

- Tube
- Eyepieces
- Objectives
- Condenser
- Lamp housings with accessories
- Fitting tool
- Depending on configuration, additional microscope accessories such as filter cubes, etc.

The CTR6000 Electronics Box, the remote control element SmartMove and the external ebq 100 supply unit* are delivered in separate packaging.

First, carefully remove all components from the transportation and packaging materials.



Note:

If at all possible, avoid touching the lens surfaces of the objectives. If fingerprints do appear on the glass surfaces, remove them with a soft leather or linen cloth. Even small traces of finger perspiration can damage the surfaces in a short time. See the chapter, "Care of the Microscope" → p. 81, for additional instructions.



Caution!

Do not yet connect the microscope and peripherals to the power supply at this point!

Installation location

Work with the microscope should be performed in a dust-free room, which is free of oil vapors and other chemical vapors, as well as extreme humidity. At the workplace, large temperature fluctuations, direct sunlight and vibrations should be avoided. These conditions can distort measurements and micrographic images.

Allowable ambient conditions

Temperature 15-35°C

Relative humidity maximum 80% up to 30°C

Microscopes in warm and warm-damp climatic zones require special care in order to prevent the build up of fungus.

See the chapter, "Care of the Microscope" → p. 81, for additional instructions.

Transport

For shipping or transporting the microscope and its accessory components, the original packaging should be used.

As a precaution to prevent damage from vibrations, the following components should be disassembled and packaged separately:

- Unscrew the objectives.
- Remove the condenser.
- Remove the stage.
- Remove the lamp housings.
- Disassemble the burner of 106 z lamp housing.
- Remove all moving or loose parts.



Caution!

Electrical components must be placed at least 10 cm from the wall and away from flammable substances.

6. Assembling the Microscope

The microscope components are logically assembled in this order:

- Stage
- Condenser
- Tube
- Eyepieces
- Objectives
- Light sources
- Filter cubes/reflectors*

Only a few commonly used screwdrivers and keys are necessary for assembly, which are included in the delivery package.

When using intermediate systems and optical accessories, the sequence may vary.

In this case, read Chapter "6.10 Optional accessories" → p. 34.

6.1 Stage



Caution:

Before assembling the stage, make sure no objectives are installed!

- Place the specimen holder on the stage and fasten it with the two screws (5.1).
- Using the condenser height adjuster (5.2), turn the condenser holder completely upwards, i.e. as close to the stage as possible.
- Loosen the stage clamp (5.3) slightly.
- From above, set the stage clamp onto the dovetail guide (6.2) and push the stage downwards until the upper end of the dovetail guide is tightly fastened to the upper end of the stage clamp.
- Firmly tighten the stage clamp (6.1).



Note:

For thicker specimens (Leica DM6000 M) the stage can be set to a correspondingly lower level.



Caution:

This changes the pre-set focus position and the lower threshold. Both positions have to be set again. See 8.3. Focusing, → p. 60.

Fig. 5 Object stage

- 1 Locking screws for specimen holder
- 2 Condenser height adjuster
- 3 Stage clamp

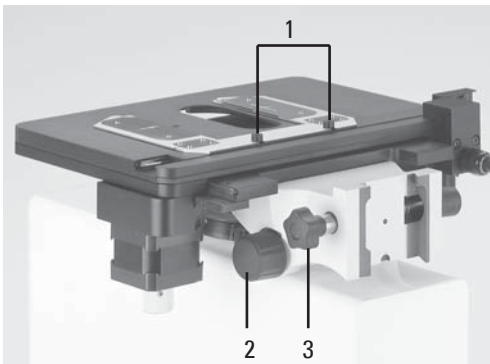

Fig. 6 Assembling the stage

- 1 Stage clamp
- 2 Dovetail guide



6. Assembly

6.2 Condenser

- Screw the condenser head into the condenser.
- Using the condenser height adjuster (7.4), turn the condenser holder (7.1) completely downwards.
- Unscrew the clamping screw for the condenser (7.3) far enough so that the condenser can be inserted from the front.
- From the front, insert the condenser into the condenser holder as far as it will go. On the underside of the condenser, there is an orientation pin (8.1), which must be located in the guiding notch (9.1).
- Pull the condenser's clamping screw (7.3) so that the condenser is locked in place.
- Connect the condenser by connecting the condenser cable (10.1) with the stand.

Fig. 7 Condenser holder

- 1 Condenser holder
- 2 Condenser centering
- 3 Clamping screw for condenser
- 4 Condenser height adjuster

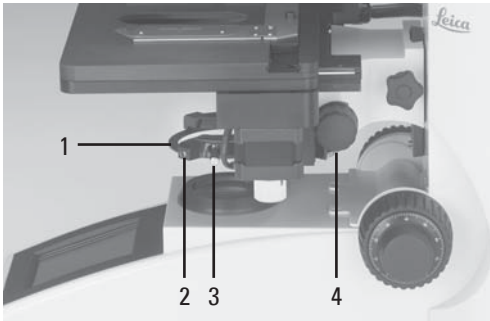

Note:

The condenser must be centered before using the microscope.

→ Köhler illumination p. 46.

Fig. 8

Underside of condenser

- 1 Orientation pin

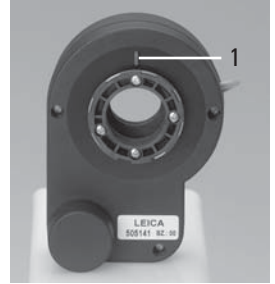

Fig. 9 Condenser holder

- 1 Guiding notch

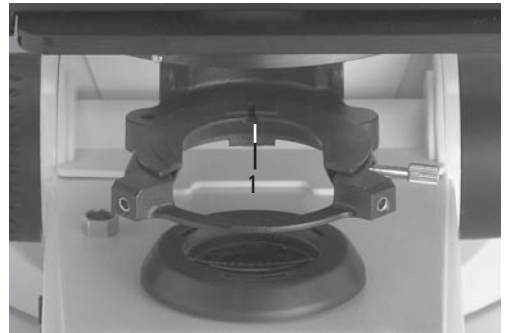
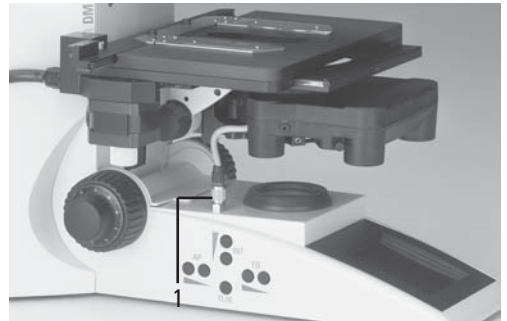

Fig. 10 Condenser connector

- 1 Condenser cable socket



6.3 Tube and Eyepieces

The tube is mounted to the stand either directly or with the use of intermediate modules. It is fastened in place with the side clamping screw (12.1).

- Only for the motorized tube MBDT:
Remove the transportation lock (11.1) from the bottom side of the tube.
- Loosen the clamping screw (12.1). on the stand.
- Insert the tube in the circular receptacle (dovetail ring).
- Retighten the clamping screw (12.1).
- Only for the motorized tube MBDT:
Connect the tube to the stand with the connector socket (13.1).
- The eyepieces are inserted into the eyepiece tubes on the tube.



Note:

For eyepieces that are not included in shipment, we recommend to learn them in with the Software Leica DMControl, module: Configuration. This ensures that the information about total magnification on the LeicaScreen is correct.

Fig. 11 Bottom side of the tube

1 Transportation lock



Fig. 12 Fastening the tube

1 Clamping screw



Fig. 13 Motorized tube connection

1 Connector socket

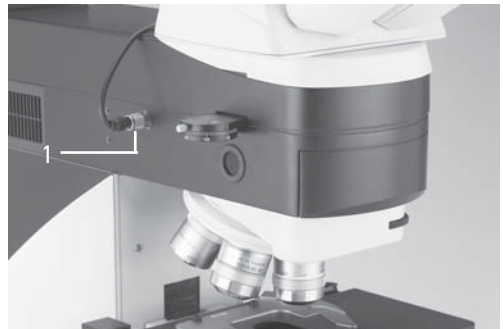

6. Assembly

6.4 Objectives

The receptacles on the objective turrets are numbered (Fig. 14). The individual objectives have already pre-assigned positions at the factory according to their configuration.

A list of the exact objective positions is provided in shipment ("Identification Sheet").



Caution:

Cover unoccupied threads on the turret with dust protector caps!



Note:

We recommend to perform a parfocality adjustment with the Software Leica DMControl, module: Fine Tuning.

Fig. 14
Objective turret
with labeled
objective
receptacles

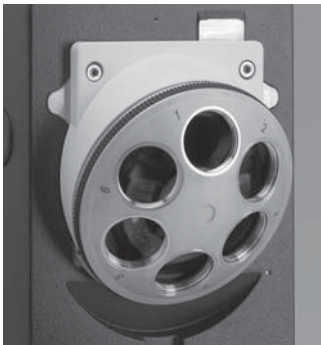

6.5 Light Sources for the Transmitted Light Axis



Caution!

Be sure that the lamp housing is disconnected from the power supply. Unplug the power plug and the power supply during assembly.



Caution!

Light sources pose a potential irradiation risk (glare, UV-radiation, IR-radiation). Therefore, lamps have to be operated in closed housings.

Fig. 15
Lamp housing 107/2
Releasing the
fastening screw



Fig. 16
Lamp housing 107/2,
opened
1 Mount with
halogen lamp
2 Collector

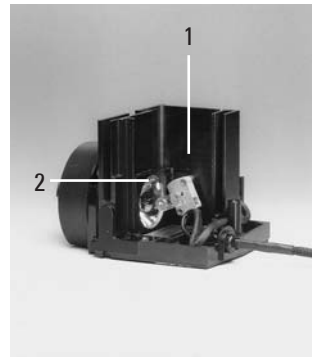

107/2 Lamp Housing

This lamp housing is used with a 12V 100W halogen lamp, which is already mounted. In case the lamp has to be removed:

- Remove the fastener screw on the housing (Fig. 15).
- Remove the housing by pulling it upwards.
- Remove the lamp.
- Insert the new 12V 100W lamp (16.1) with the dust cover straight into the socket until it stops. Be sure that the lamp is inserted straight.
- Remove the lamp's dust cover.



Caution!

Do not remove the lamp's dust cover until you have installed the lamp. Avoid fingerprints on the lamp.

- Replace the housing and fasten it in place using the fastening screw.
- Place the lamp housing in the transmitted light lamp housing receptacle (17.2) and fasten it with the clamping screw on the side.
- Connect the lamp housing to the power supply for transmitted light (symbol: \triangle) (17.3).
- Now connect the lamp power cable of the microscope (17.5) to the Leica CTR6000 Electronics Box (18.1).

Fig. 17 Rear side of stand

- 1 Incident light lamp housing receptacle
- 2 Transmitted light lamp housing receptacle
- 3 12 V 100 W connection for transmitted light (symbol: \triangle)
- 4 12 V 100 W connection for incident light (symbol: ∇)
- 5 Lamp power cable

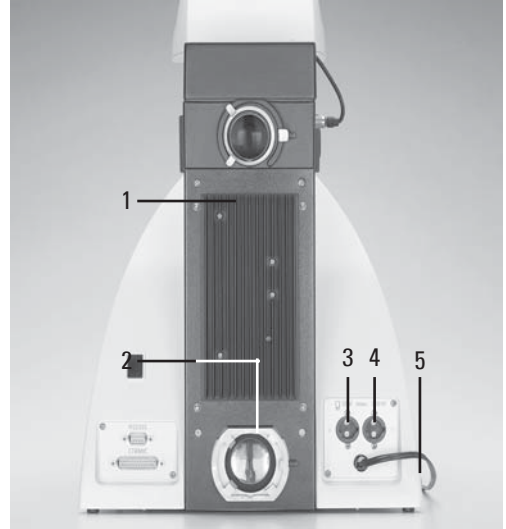
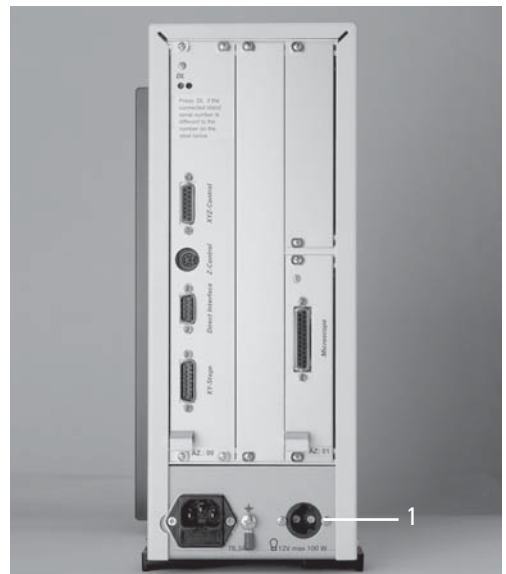

Fig. 18 Rear side of Leica CTR6000

- 1 Connection for lamp power cable from the stand



6. Assembly

6.6 Light Sources for the Incident Light Axis



Caution!

Light sources pose a potential irradiation risk (glare, UV-radiation, IR-radiation). Therefore, lamps have to be operated in closed housings.

During assembly, always unplug the power supply unit of the 106 z lamp housing from its socket.

During assembly work on xenon burners, always wear the supplied protective gloves and face protection (Fig. 19) (risk of explosion).

Never touch the glass parts of the burner with bare hands.

Never look directly into the beam path (blinding hazard).

Fig. 19
Protective gloves and mask



106 z lamp housing

This lamp housing is used with a 12V 100W halogen lamp or various gas discharge lamps.



Caution!

Make sure to follow the instructions and safety notes of the lamp supplier.

Before changing lamps allow at least 30 mins for cooling down!

Fig. 20 106 z lamp housing (on the side, open)

- 1 Cover raised
- 2 Collector
- 3 12 V 100 W lamp or gas discharge lamp in mount
- 4 Reflector (mirror)
- 5, 6, 7 Adjusting screw for x-y reflector
- 8 Fastening screw for lamp mount
- 9 Socket for contact plug

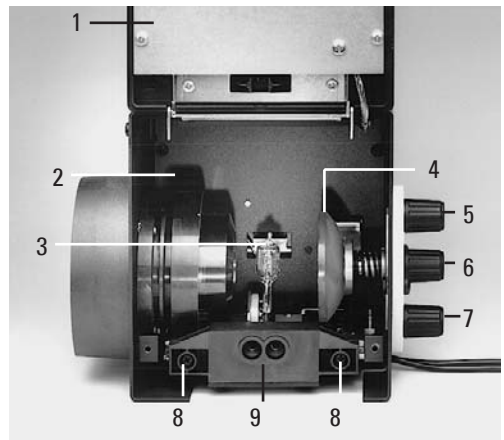

Inserting the 12V 100W halogen lamp into the 106 z lamp housing

- Unscrew the fastening screws of the cover and lift up the cover (20.1).
- Unscrew the fastening screws of the lamp mount (20.8) and pull out the mount (Fig. 21).
- Insert the lamp with the dust cover straight into the socket until it stops.



Caution!

Do not remove the lamp's dust cover until you have installed the lamp. Avoid fingerprints on the lamp.

- Remove the dust cover.

- Reinsert the lamp mount and retighten the fastening screw (20.8).
- Close the lamp housing and retighten the fastening screws.
- Place the lamp housing in the incident light lamp housing receptacle (22.1) and fasten it with the clamping screw on the side.
- Connect the lamp housing to the power supply for incident light (symbol ∇) (22.4).
- Now connect the lamp power cable of the microscope (22.5) to the Leica CTR6000 electronics box (18.1, p. 25)

Fig. 21 Lamp mount with 12 V 100 W halogen lamp

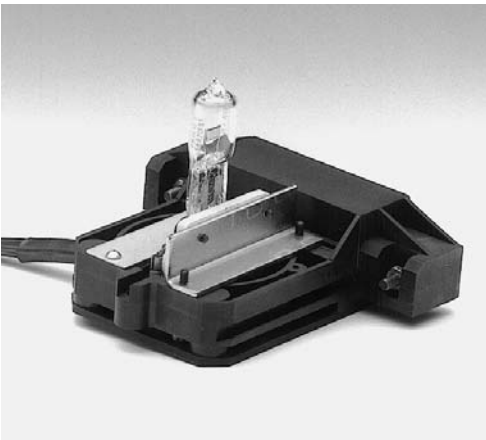
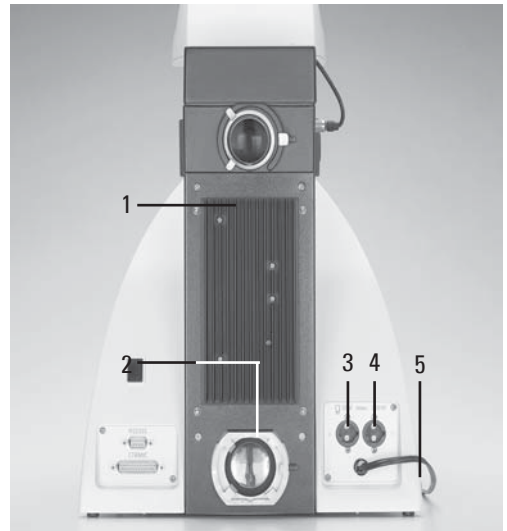

Fig. 22 Rear side of stand

- 1 Incident light lamp housing receptacle
- 2 Transmitted light lamp housing receptacle
- 3 12 V 100 W connection for transmitted light (symbol: Δ)
- 4 12 V 100 W connection for incident light (symbol: ∇)
- 5 Lamp power cable



6. Assembly

Inserting the gas discharge lamps (Hg and Xe) into the 106z lamp housing

Hg and Xe lamps are powered by separate supply units.

Read the separate instruction manual provided with these supply units.

The following gas discharge lamps may be used and require different supply units and lamp mounts (Fig. 23):

Type	Typical bulb life*
50 W high-pressure mercury burner (alternating current)	100 hrs.
100 W high-pressure mercury burner (direct current)	200 hrs.
100 W high-pressure mercury burner (direct current, type 103 W/2)	300 hrs.
75 W High-pressure xenon burner (direct current)	400 hrs.

* Please regard the data sheets of the burners.

- To open the 106 z lamp housing, unscrew the fastening screws on the cover.
- Remove the transport anchorage (red plastic rod in place of the burner) in the lamp mount. To do so, remove the lower clamp (23.1). Pull up the cooling element (23.3) and turn it to the side. Detach the lower clamp system (23.2) and remove the transport anchorage.
- Install the burner in reverse order.

**Caution!****Hg 50 burner:**

After installation, the labeling must be upright. If a glass melt nipple is present (23a.4), position it by turning the burner so that the nipple does not come in the way of the beam path later, but instead is positioned sideways.

Xe 75 burner:

Remove the burner's dust cover (23b.5) after you have installed the burner.

Fig. 23 a-c Lamp mounts for gas discharge lamps

- 1** Upper clamping system, **2** Lower clamping system, **3** Cooling element
4 Nipple of the mercury 50 burner, **5** Dust cover of the mercury 75 burner

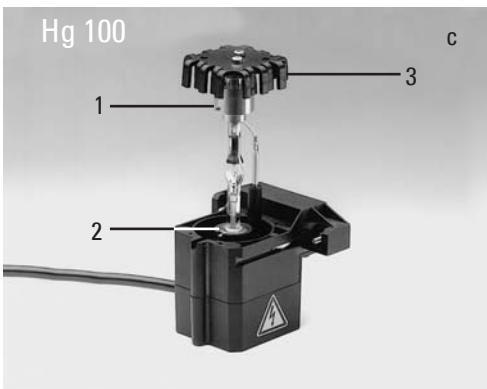
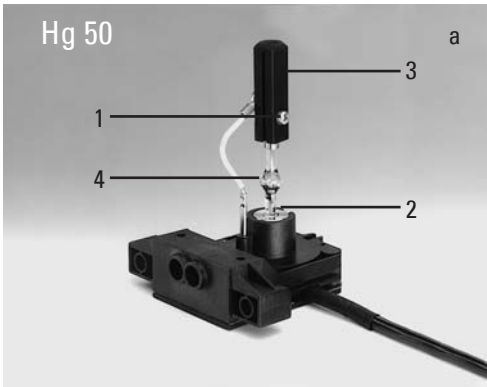

6. Assembly

- Insert the lamp mount, with the burner installed, into the lamp housing and tighten it with the screws (24.8).
- Put the lid down again. Plug in the contact plug as far as it goes and retighten the screws.
- Place the lamp housing in the incident light lamp housing receptacle (25.1) and fasten it with the clamping screw on the side.
- Connect the lamp housing to the power supply (26.1).

Fig. 25 Rear side of stand

- 1 Incident light lamp housing receptacle
- 2 Transmitted light lamp housing receptacle
- 3 12 V 100 W connection for transmitted light (symbol: Δ)
- 4 12 V 100 W connection for incident light (symbol: ∇)
- 5 Lamp power cable

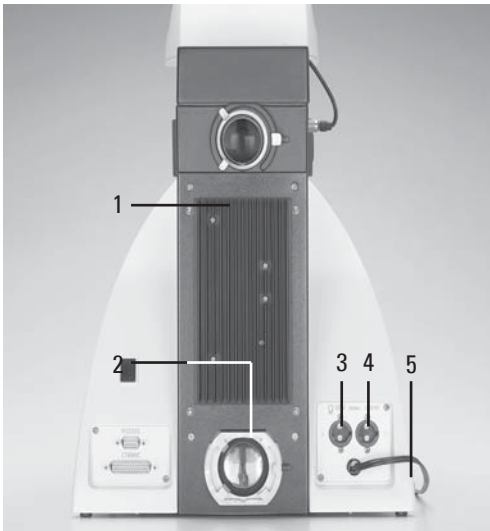

Fig. 24 106 z lamp housing (on the side, open)

- 1 Cover raised
- 2 Collector
- 3 12 V 100 W lamp or gas discharge lamp in mount
- 4 Reflector (mirror)
- 5, 6, 7 Adjusting screw for x-y reflector
- 8 Fastening screw for lamp mount
- 9 Socket for contact plug

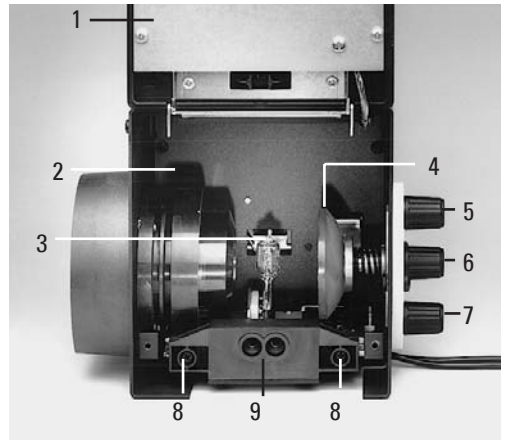

Fig. 26 Rear side of the ebq 100 supply unit

- 1 Lamp connection



6.7 Equipping the Incident Light Turret Disc

The receptacles on the turret are numbered. According to your equipment, the individual filter and/or reflector cubes have already pre-assigned positions. A list is provided along with your shipment (“identification sheet”).

Insert the filter and reflector cubes in the following manner:

- Equip the incident light turret only when the microscope is switched off.
- Remove the front cover from the upper part of the microscope (Fig. 29). Push the retention pin (29.2 or 30.2) to move the turret. Releasing the retention pin locks the turret.
- Insert the filter or reflector cube into the mounting in front of you according to the identification sheet provided. To do so, place the filter or reflector cube on the **right** side and press it to the **left** into the mounting (Fig. 31).

Fig. 27 Filter cube front side



Fig. 28 Filter cube back side

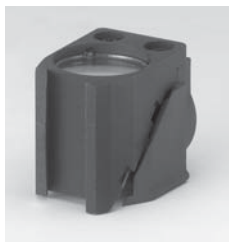

Fig. 29 Removing the front cover (4-fold filter turret)

- 1 Filter receptacle
- 2 Retention pin
- 3 Front cover

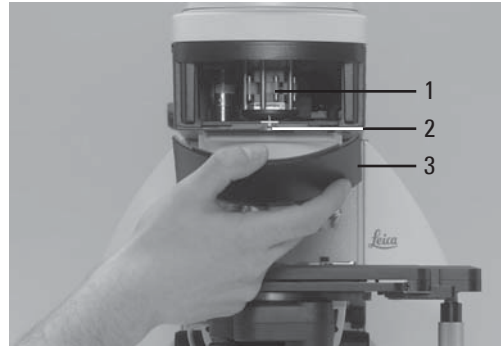

Fig. 30 8-fold filter turret (front cover removed)

- 1 Filter receptacle
- 2 Retention pin

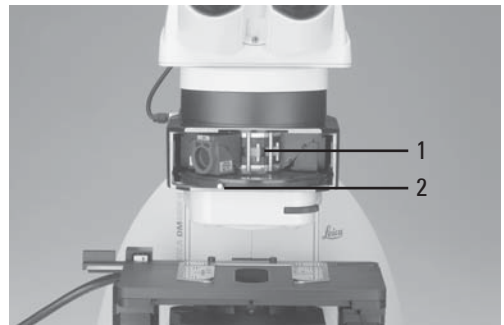

Fig. 31 Inserting the filter or reflector cubes

- 1 Mounting





Note:

At the 4-fold and 5-fold filter turrets, the numbers are right below the mounting. At the 8-fold turret, the numbers are on the bottom of the disc.

- Push the retention pin (29.2 or 30.2) and continue to turn the filter turret until you reach the next locking position.
- Again make sure that the turret engages (retention pin unlocks) and insert the next filter and/or reflector cube as described above.
- When all filters and reflector cubes have been inserted, close the front cover plate again.



Note:

At the Leica DM6000 M, 2 positions for bright field and dark field reflector cubes may be set (depending on configuration).



Note:

Filter cubes that are not included in shipment have to be learned in with the Software Leica DMControl, module: Configuration.

6.8 Polarizer and Analyzer

ICT/P transmitted light polarizer

- Using the left clamping screw, fasten the ICT/P transmitted light polarizer to the underside of the condenser holder (Fig. 32).
- Make sure that the red index point on the front of the polarizer is aligned with 0.
- If necessary, insert the compensators (λ - and $\lambda/4$ plates) into the polarizer's receptacle (Fig. 33).

Incident light polarizers:

R/P polarizer, rotating polarizer

L/ICR, R/ICR polarizer

- Remove the plug cap on the right side of the incident light axis (Fig. 34).
- Insert the polarizer into the receptacle until it latches in place.



Attention:

Insert the polarizer only in the front receptacle!

Fig. 32 Assembly of the ICT/P transmitted light polarizer
1 Clamping screw

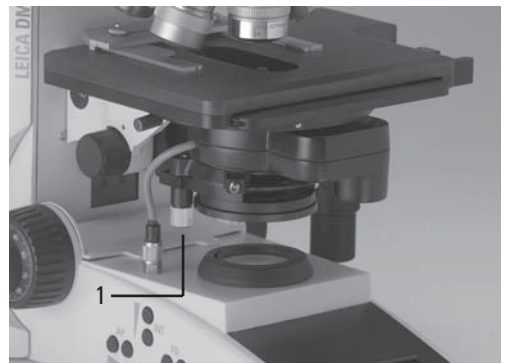

Motorized polarizer

- A motorized polarizer is already installed and ready for operation in the DIC condenser.

Transmitted light and incident light analyzer

- Remove the plug cap on the left side of the stand.
- Insert the analyzer into the receptacle until it latches in place (Fig. 35).

Motorized analyzer

- Insert the analyzer cube as described in section 6.7 "Equipping the Incident Light Turret Disc" → p. 31, in the corresponding position on the filter turret. See the list provided ("Identification Sheet") for the correct position.

6.9 DIC Prisms

With the microscope Leica DM6000 B the DIC objective prisms are already mounted in the DIC turret above the objective revolving nosepiece (Fig. 34.2).

Fig. 33 Inserting the compensators

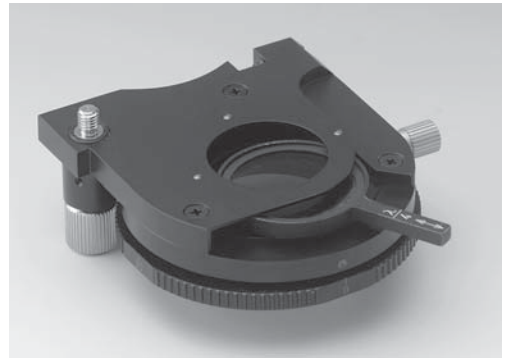

Fig. 34 Inserting the polarizer

- 1 The plug cap is replaced with the polarizer.
- 2 Knurled wheel for fine adjusting the DIC prisms

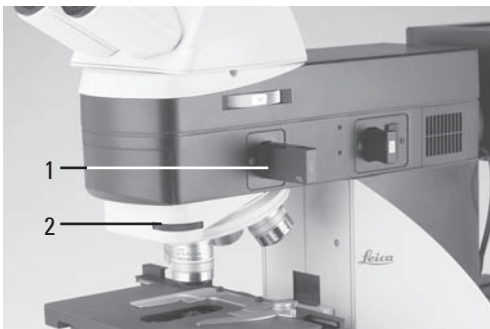
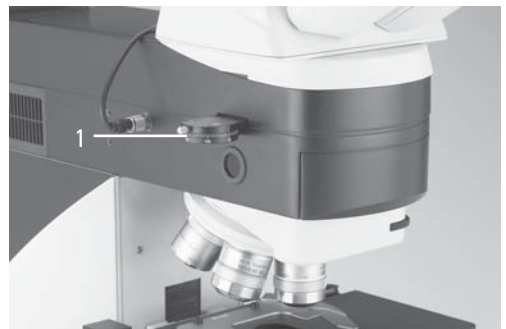

Fig. 35 Inserting the analyzer

- 1 The plug cap is replaced with the analyzer.



6.10 Optional Accessories

Camera

Connecting a camera

A camera can be connected via c-Mount or Vario-Mounts.

- Attach the c-Mount or the Vario-Mount to the top port of the tube and fasten it tightly with the side clamping screw.
- Screw on the camera.

**Note:**

The use of a c-Mount or a Vario-Mount should be learned in with the Software Leica DMControl, module: Configuration.

Connecting two cameras

The dual port enables you to connect two cameras (one digital and one analog) to the microscope.

- When using a DC-type digital camera, the camera is connected to the PCI-card of the PC.
- When using a DFC-type digital camera, the camera is connected to the Fire Wire card of the PC.

**Note:**

Please see the separate operating manual of the digital camera.

**Note:**

When retrofitting the tube with a dual port, both ports should be centered by the technical service.

Ergomodule

For raising the eye level of the tube opening, the ergomodule may be used.

It is fastened in place with the side clamping screw.

Mirror Housing

- Place the mirror housing directly onto the lamp housing receptacle on the back of the stand and attach it using the side clamping screw.
- Place the lamp housing onto the mirror housing and fasten it using the corresponding clamping screw on the side.

Booster Lens/Excitation Manager

- Insert the filter slide into the front receptacle on the right side of the stand (36.1, 37.1).
- Booster Lens and Excitation Manager can not be used simultaneously.

Fig. 36

1 Insert of Booster Lens



Fig. 37

1 Insert of Excitation Manager



6. Assembly

6.11 Connecting the Leica CTR6000 Electronics Box



Note:

We generally advise you **not** to use the Leica CTR6000 box with other microscopes. The serial no. of the matching stand can be found on the rear side of the electronics box.

- Plug one connector of the 25-pin cable into the socket on the back of the microscope (39.2) and the other into the **Microscope** port (38.6) on the back of the Leica CTR6000 box.

Fig. 38 Rear side of Leica CTR6000

- 1 Socket for mains cable
- 2 Socket **XY-Stage** for motorized stage
- 3 Socket **Direct interface** optional
- 4 Socket **Z-Control** for separate focus control unit
- 5 Socket **XYZ-Control** for SmartMove
- 6 Socket **Microscope** for microscope
- 7 Socket **12V, max 100W** for lamp power cable of the stand
- 8 DL: Reset button

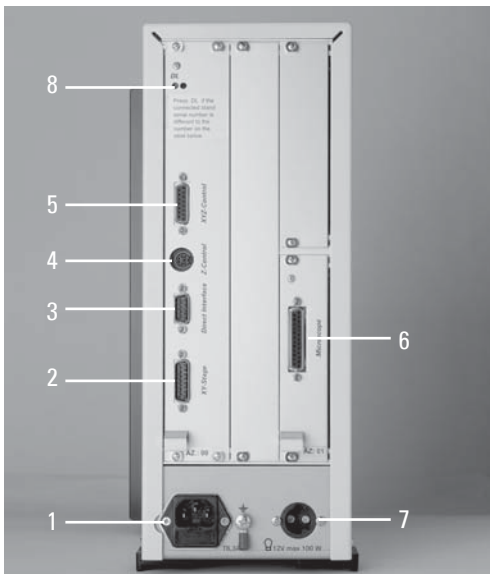

- Connect the remote control element Smart-Move to the socket **XYZ-Control** (38.5).
- Connect the motorized stage to the socket **XY-Stage** (38.2).
- If the lamp power cable of the microscope (39.3) has not been connected during assembly, connect it now to the socket **12V, max 100W** (38.7).



Caution!

To avoid overheating of the ports, make sure the plugs are connected properly and screwed on tightly.

Fig. 39 Rear side of stand

- 1 RS232-interface
- 2 Connection to the Leica CTR6000 electronics box
- 3 Lamp power cable of the microscope

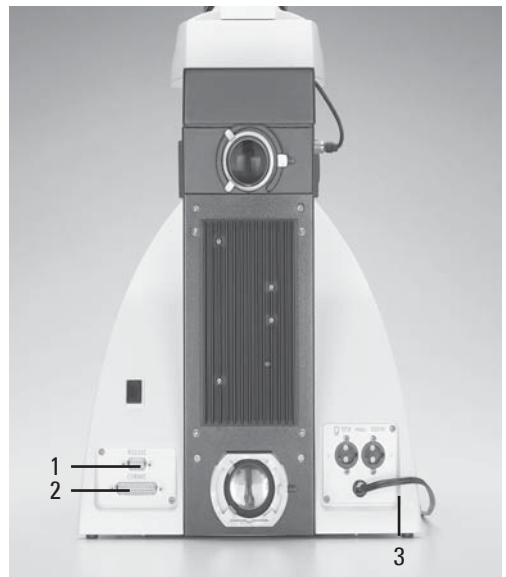

6.12 Connecting the Computer



Note:

To start the Leica DMControl, the COM1 serial interface must not be occupied by another program or driver. However, this often happens when using palmtops or other electronic planners and installing additional modems or devices. The accessory devices **always** have to be deactivated before using the Leica DMControl software.

- Connect the COM1 serial interface of the computer to the **RS232C** (39.1) port on the back of the stand. Use the serial cable supplied.

6.13 Connection to the Power Supply

- After completing the assembly work, connect the Leica CTR6000 electronics box to the power supply using the power cable supplied (port 38.1).
- When using the ebq 100 supply unit, this also has to be connected to the power supply (port 40.1).

Fig. 40 Rear side of the ebq 100 supply unit
1 Port for power supply cable

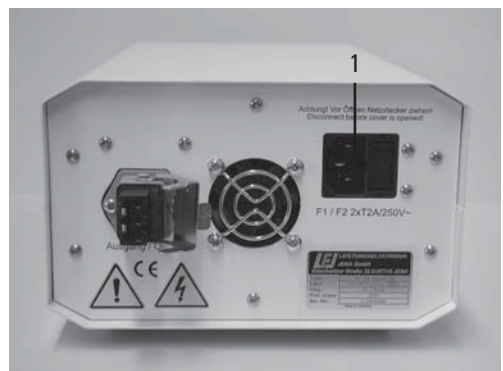

7. Startup

7.1 Functional Principle

Based on an intelligent automation concept, the Leica DM6000 B/M can be operated via several control elements.

1. Intelligent automation

- Switch between different contrasting methods by pressing just one button. Light rings, DIC-prisms, etc. are inserted into the beam path automatically.
- The microscope recognizes the objective in use and the corresponding contrasting method. Therefore, the values for intensity (INT), aperture diaphragms (AP) and field diaphragms (FD) are always set appropriately.
- The information about INT, AP and FD is always given with regard to the currently activated light axis (transmitted light or incident light).
- The values for INT, AP and FD can be changed individually. This overwrites the previous settings. Actual settings are stored automatically and can be recalled when switching on the microscope again.

2. Control elements

- LeicaScreen
Controls the microscope's functions via touch screen.
- SmartMove
For stage and focus control
- Fixed function keys at the stand
For INT, AP, FD and to switch between transmitted light and incident light.
- Variable function keys at the stand and at the SmartMove
The function keys are assigned logical functions before delivery, corresponding to the configuration of your microscope. These functions can be re-programmed according to your individual requirements.
- Entire control of microscope and camera via software
(Leica DMControl, Leica application software)

**Note: (Reset-Function)**

The microscope can be reset to the default settings:

- When the microscope is switched off, press all 3 variable function keys on the left stand section.
- Switch on the stand.
- Hold the keys pressed down until initialization is completed.
- The standard information is shown in the LeicaScreen.
- Switch off the instrument and switch it on again. The settings are stored now.

The table on the opposite page shows which microscope components can be operated with which control elements.

7. Startup

Function	LeicaScreen	Fixed Function Keys at the Stand	Variable Function Keys at the Stand and at the SmartMove	Turning Knobs SmartMove	Software DMControl
Change contrasting methods	+	-	(+)	-	+
Toggle between TL and IL	+	+	-	-	+
Select objectives	+	-	(+)	-	+
learn in parfocality	-	-	-	-	+
change operating mode (Dry/Imm)	+	-	-	-	+
Illumination manager	-	+	(+)	-	+
Magnification changer	manual operation only				
Focusing	-	-	-	+ ¹⁾	+
set thresholds	+	-	-	-	+
go to thresholds	+	-	(+)	-	+
change step size (Coarse/Fine)	+	-	-	-	+
XY-stage positioning	-	-	-	+	+
change speed	+	-	-	-	+
go to/set stage positions	-	-	-	-	+
Motorized tube (change beam splitting)	+	-	(+)	-	+
Select filter/reflector cube	+	+	(+)	-	+

+ always possible



(+) optional

- not possible

¹⁾ Focusing also possible via manual focus knobs

Possible assignments for the variable Function Keys at the stand and at the SmartMove

For Leica DM6000 B:

Function key	Meaning
BF	Bright field (transmitted light)
PH	Phase contrast (transmitted light)
ICT	Interference contrast (transmitted light)
DF	Dark field (transmitted light)
POL	Polarization (transmitted light)
CHANGE TL 	Switch through all transmitted light processes
INT ↑	Increase brightness (transmitted light)
INT ↓	Reduce brightness (transmitted light)
AP ↑	Open aperture diaphragm (transmitted light)
AP ↓	Close aperture diaphragm (transmitted light)
FD ↑	Open field diaphragm (transmitted light)
FD ↓	Close field diaphragm (transmitted light)
SHUTTER TL	Open/close transmitted light shutter
FLUO	Fluorescence (last filter cube)
CUBE 1	Select fluorescence cube at position 1
CHANGE CUBE CW	Switch through fluorescence cubes in clockwise fashion (1 → 4)
CHANGE CUBE CCW	Switch through fluorescence cubes in counterclockwise fashion (4 → 1)
SHUTTER FLUO	Open/close fluorescence shutter
INT FLUO ↑	Increase brightness (fluorescence)
INT FLUO ↓	Reduce brightness (fluorescence)
FD FLUO ↑	Open field diaphragm (fluorescence)
FD FLUO ↓	Open field diaphragm (fluorescence)
COMBI 	Combination mode (PH/fluorescence or ICT/fluorescence)
CHANGE COMBI 	Switch through all combination modes
CHANGE TUBE	Toggle between different beam splitting modes
100% VIS	100% Documentation port
50:50	50% Documentation port/50% Camera
100% CAMERA	100% Camera
CHANGE OBJ CW	Switch through objectives in clockwise fashion
CHANGE OBJ CCW	Switch through objectives in counterclockwise fashion
UPPER Z	Go to upper threshold
LOWER Z	Go to lower threshold

7. Startup

For Leica DM6000 M:

Function key	Meaning
BF	Bright field (incident light)
ICR	Interference contrast (incident light)
DF	Dark field (incident light)
POL	Polarization (incident light)
CHANGE RL ●	Switch through all incident light processes
INT ↑	Increase brightness (incident light)
INT ↓	Reduce brightness (incident light)
AP ↑	Open aperture diaphragm (incident light)
AP ↓	Close aperture diaphragm (incident light)
FD ↑	Open field diaphragm (incident light)
FD ↓	Close field diaphragm (incident light)
SHUTTER RL	Open/close incident light shutter
FLUO	Fluorescence (last filter cube)
CUBE 1	Select fluorescence cube at position 1
CHANGE FLUO	Switch through fluorescence cubes
FOCUS FINDER	Select smallest field diaphragm and switch back to original field diaphragm by pressing the key again
BF TL	Bright field (transmitted light)
INT ↑	Increase brightness (transmitted light)
INT ↓	Reduce brightness (transmitted light)
AP ↑	Open aperture diaphragm (transmitted light)
AP ↓	Close aperture diaphragm (transmitted light)
FD ↑	Open field diaphragm (transmitted light)
FD ↓	Close field diaphragm (transmitted light)
COMBI ●	Combination mode (BF and BF TL)
CHANGE TUBE	Toggle between different beam splitting modes
100% VIS	100% Documentation port
50:50	50% Documentation port/50% Camera
100% CAMERA	100% Camera
CHANGE OBJ CW	Switch through objectives in clockwise fashion
CHANGE OBJ CCW	Switch through objectives in counterclockwise fashion
UPPER Z	Go to upper threshold
LOWER Z	Go to lower threshold

7.2 Switching on

- Start with the objective with the lowest magnification.
- Switch on the Leica CTR6000 Electronics Box at the on/off switch (41.1). When in operation, the pilot lamp will light up green (41.2). All motorized microscope components first undergo an initialization phase.



Note:

If you have connected a PC, please switch on **the electronics box first** and **the computer afterwards**.

After initialization is completed, the LeicaScreen shows the current microscope setting (Fig. 42).

Fig. 41

- Front view of the Leica CTR6000 box
- 1 On/off switch
 - 2 Pilot lamp



If one of the components is not mounted properly, e.g. the cover of the filter turret is not locked in place, an error will show up on the LeicaScreen.

See chapter 'Trouble Shooting', → p. 80.

The microscopic components such as diaphragms, condenser, light and phase rings are already pre-centered in the factory. However, re-centering may be necessary due to transportation and assembly.









Before proceeding with the necessary steps, first familiarize yourself with the LeicaScreen and control panel.



Caution!

After turning on the gas discharge lamp, the burner must be immediately adjusted. Therefore, **do not** turn on the power supply unit yet. First, work in transmitted light in order to familiarize yourself with the microscope's controls.

Fig. 42 LeicaScreen after initialization

	Status	Light	XYZ
	TL	BF	
	1.25x		1.0 x
	100 % - 0 %		
	 12.5x		-987 μm
			

7.3 The LeicaScreen

On the status page, the LeicaScreen shows the current microscope settings. The display depends on the microscope's configuration. Apart from this, the microscope can be operated via several menu levels on the LeicaScreen.

Please see the abbreviation index for a list of abbreviations used → p. 84.

Read the separate instruction manual of the LeicaScreen.

The display represents different levels of operation:

Level 1: Navigation panel

Level 2: Menu bar

Level 3: Information and control panel

After selecting a pictogram on the navigation panel (left column on the display), the corresponding menu bar opens in the upper row of the display. The items on the control panel change accordingly. The currently active functions are highlighted in black.

Navigation panel

The navigation panel allows for quickly selecting the navigation items:



Basic setting of microscope



Contrast Method



Magnification



Documentation port



Stage and focus settings



LeicaScreen configuration

Menu Bar

Each navigation item contains several menus that can be selected via the menu bar. The currently activated menu is highlighted in black.

Information and control panel

This area shows the current settings and functions that can be operated from this menu.

Items that are compatible with the current settings are marked with a black triangle.

7.4 The Function Keys at the stand

There is a row of function keys both on the right and left side of the stand. Some of these keys are defined, and some of them are variable. The variable function keys have various meanings depending on the microscope configuration.

Defined Function Keys on the left side of the stand

The **TL/IL** key (43.1) switches between incident light and transmitted light. The last contrast method used is restored.

The **INT** (43.3) keys adjust the light intensity individually. Settings can be made either in large or small increments. Pushing both **INT** buttons at the same time switches between coarse and fine setting. If the fine setting has been selected, the display indicates „Intensity fine“.

The **AP** (43.2) keys for the aperture diaphragm and **FD** (43.4) for the field diaphragm are used to open/close each diaphragm.



Note:

Changes in light intensity and settings of aperture and field diaphragms are stored for the current objective and contrasting method.

Variable Function Keys at the stand

A factory preset is performed which fits your microscope configuration. The function keys are labeled accordingly, and a separate description of the key occupation accompanies the microscope (“Identification Sheet”).

Abbreviations are listed on p.41f.



Note:

The setting of the variable function keys can only be altered via the Software Leica DMControl, module: Configuration.

Fig. 43 Defined Function Keys

- 1 Transmitted light/incident light
- 2 Aperture diaphragm
- 3 Light Intensity
- 4 Field diaphragm

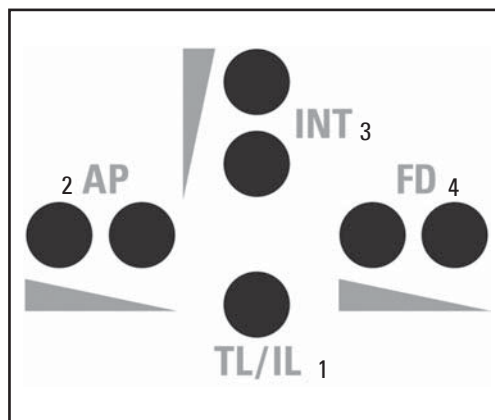

7. Startup

7.5 The Remote Control Element SmartMove

Turning knobs at the SmartMove

The specimen stage can be moved in x/y direction with the turning knobs (44.1, 44.2). The image can be focused with the turning knob (44.3). The image can be focused with the turning knob (44.3).

The height of the turning knobs can be adjusted to your individual needs with the screw (44.4).

Variable function keys at the SmartMove

The function keys are assigned logical functions before delivery, corresponding to the configuration of your microscope. The keys are labeled accordingly. For the setting of the keys, see 'Identification Sheet'.

For the list of abbreviations see page → 41f.



Note:

The setting of the variable function keys can only be altered via the Software Leica DMControl, module: Configuration.

7.6 Köhler Illumination

7.6.1 Transmitted Light

For each objective, reasonable values for the aperture diaphragm and the field diaphragm are already set. The condenser is also pre-adjusted in the factory.

However, it may be necessary to re-adjust the condenser in some cases. Therefore, check the condenser centering.

The following procedure is provided for the transmitted light-bright field illumination.

Fig. 44 Remote Control Module SmartMove

- 1 Move in x-direction
- 2 Move in y-direction
- 3 Focus
- 4 Height adjustment
- 5 Variable function keys (factory pre-set)

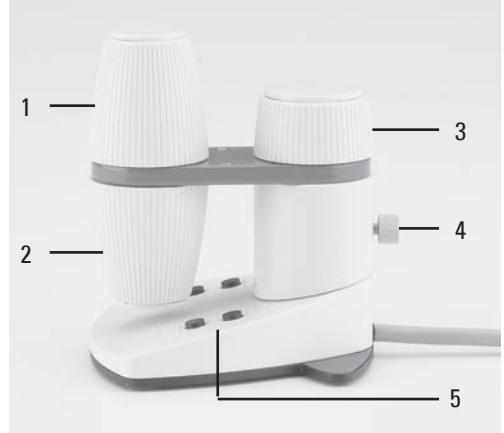
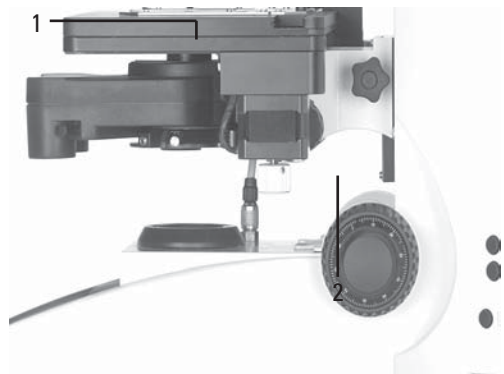

Fig. 45 Stage with specimen holder

- 1 Specimen holder
- 2 Condenser height adjuster



- Select an objective with moderate magnification (10x-20x).
- If necessary, activate the transmitted light axis by pushing the **TL/IL** button (43.1).
- Choose "bright field" as the contrast method by pressing the **BF** key (one of the variable function keys at the stand or at the LeicaScreen).
- Insert the specimen in the stage's specimen holder (45.1).
- Focus on the specimen with the SmartMove or focus wheel.
- Set the light intensity using the **INT** keys (43.3).
- Close the field diaphragm with the **FD** function key (43.4) until the edge of the diaphragm appears in the specimen plane.
- Using the condenser height adjuster (45.2), adjust the condenser until the edge of the field diaphragm appears in sharp relief.
- If the image does not appear in the middle of the field of view (47c), the condenser must be moved into the middle of the field of view with the help of the two centering bolts (46.1).
- Open the field diaphragm just enough for it to disappear from the field of view (47d).

**Caution:**

The light of the condenser depends on the thickness of the specimen. It has to be adjusted for each specimen.

Fig. 46 Condenser centering

1 Centering bolts

**Fig. 47** Köhler Illumination

- Field diaphragm not focused, not centered
- Field diaphragm focused, but not centered
- Field diaphragm
Diameter is too small, however
- Field diameter (light) = Field diameter (view)
(Köhler Illumination)

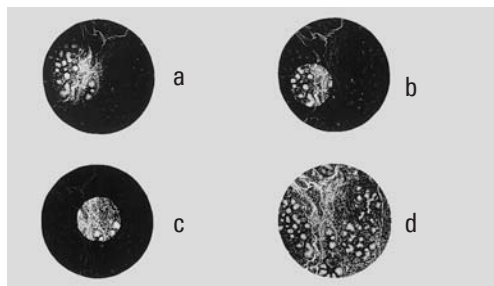

7. Startup

7.6.2 Incident Light

For each objective there are reasonable values assigned to aperture and field diaphragm. The incident light module is also pre-centered at the factory.

Due to transportation and setup of the stand, however, you might have to re-center the incident light module. Please check the aperture and field diaphragm centering.

The following procedure refers to the incident light bright field illumination.

- Select an objective with moderate magnification (10x-20x)
- If necessary, activate the incident light axis by pressing the TL/IL key (43.1).
- Activate the bright field contrasting method by pressing IL-BF/Fluo (one of the variable function keys at the stand or at the LeicaScreen).
- Insert the specimen in the stage's specimen holder (45.1).

- Focus on the specimen with the SmartMove or focus wheel.

- Adjust the light intensity with the **INT** keys (43.3).

Adjusting the field diaphragm

- Close the field diaphragm with the **FD** keys (43.4) until the edge of the diaphragm (round or rectangular) appears on the specimen plane.
- If the boundaries of the field diaphragm are not in the center of the field of view, the diaphragm has to be moved with the two centering bolts (48a.1) on the right side of the stand.
- With the function keys **FD** (43.4) on the left side of the stand, open the field diaphragm until it just disappears from the field of view.
- When using a digital camera, rectangular field diaphragms are recommended. Adjust the size of the diaphragm to the chip size of your camera.

Fig. 48a Adjusting the field diaphragm in the incident light axis

- 1 Centering bolts for moving the field diaphragm

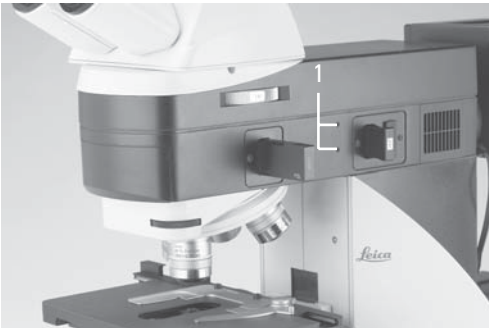

Fig. 48b Adjusting the aperture diaphragm in the incident light axis

- 1 Centering bolts for moving the aperture diaphragm



Adjusting the aperture diaphragm

(DM6000 M only)

- Remove one eyepiece.
- Close the aperture diaphragm with the **AP** keys (43.2) until the edge of the diaphragm appears on the exit pupille of the objective (aperture field plane).
- If the image does not appear in the center of the field of view, the aperture diaphragm has to be moved with the two centering bolts (48b.1) on the upper left side of the stand.
- Open the aperture diaphragm so it covers approx. 2/3 of the field of view .

Fig. 49 Focusing telescope

- 1 Adjustable eyelens
- 2 Clamping ring for fixing the focus position



7.7 Checking Phase Contrast Rings

If your microscope is equipped for the use of phase contrast, the light rings that fit the objectives are built into the condenser.

The light rings are already centered in the factory. However, the centering should be rechecked.



Note:

Every objective is assigned its own light ring in the condenser disc. Therefore, a check must be performed for each objective. When swiveling in a suitable objective for phase contrast, the corresponding light ring is set automatically.

- Press the **BF** (Bright Field) button (one of the variable function keys at the stand or at the LeicaScreen).
- In the place of an eyepiece, insert the focusing telescope (Fig. 49) into the observation tube.
- Select the phase contrast objective with the lowest magnification (one of the variable function keys at the stand or at the SmartMove).
- Focus on the specimen with the SmartMove or focus wheel.

7. Startup

- Focus the ring structure (50a) by slightly loosening the clamping ring (49.2) and moving the eyelens (49.1).
- Retighten the clamping ring.
- Press the **PH** (Phase Contrast) button (one of the variable function keys at the stand or at the LeicaScreen). The ring diaphragm in the condenser is pivoted in.
- If the light ring and the phase ring are not shown as arranged in Fig. 50c, the light ring must be centered.
- Insert the centering key through the corresponding openings (51.1) in the condenser holder.
- Turn the centering screws until the dark ring (phase ring in the objective) is congruent with the slightly narrower bright ring (light ring in condenser) (50 c).



Caution!

During change of objectives the centering keys must not remain in the openings of the condenser. They can block the condenser.

- Repeat the process for all other phase contrast objectives.
- Remove the centering keys after the centering procedure.

Fig. 50 Phase contrast centering procedure

PH=phase contrast ring, LR=light ring

- a Condenser in bright field (BF) position
- b Condenser in phase contrast (PH) position
Light ring (LR) not centered
- c Light ring and phase ring centered

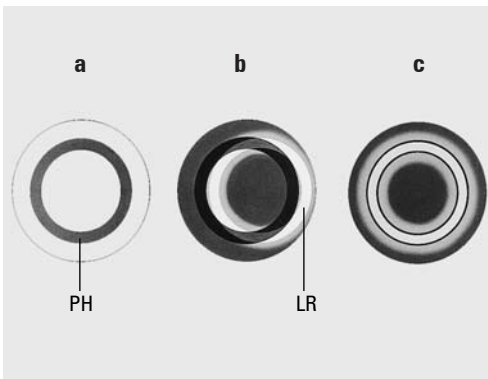
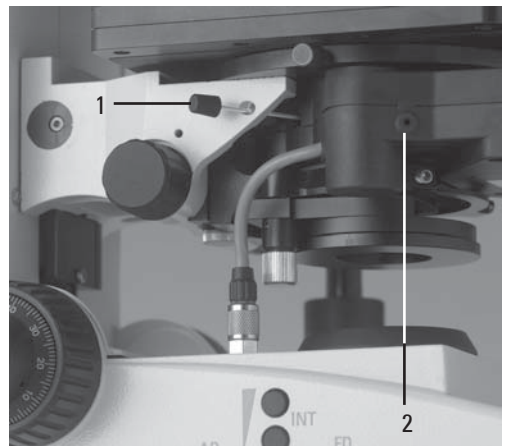

Fig. 51 Light ring centering

- 1 Centering key
- 2 Opening for centering of motorized polarizer



7.8 Adjusting Motorized Polarizer

- Select **POL** contrast method (one of the variable function keys at the stand or at the LeicaScreen).
- Inserting centering key through the corresponding opening (51.2).
- Turn it until maximum darkness is reached.

7.9 Adjusting the Light Sources

Transmitted Light Axis (TL) with 107/2 Lamp housing

The 107/2 lamp housing with 12 V 100 W halogen lamp has a defined presetting. The lamp need not to be centered.

Incident light axis (IL) with 106 z lamp housing

- When a supply unit is used, it is turned on first.
- Activate the incident light axis using the **TL/IL** function key. **FLUO** (Leica DM6000 B) or **IL** (Leica DM6000 M) appears in the LeicaScreen.
- Insert the reflector cube for lamp adjustment (Fig. 52) into the filter turret in place of a filter cube. (See → p. 31).
Note the name of the exchanged filter cube.



Note:

To avoid incorrect adjustment, we recommend to remove the filter cube on the left side of the reflector cube.

- Turn the reflector into the beam path.
The reflector has reached the correct position when the name of the exchanged filter cube is shown in the upper right of the LeicaScreen .

Fig. 52 Reflector cube for lamp adjustment

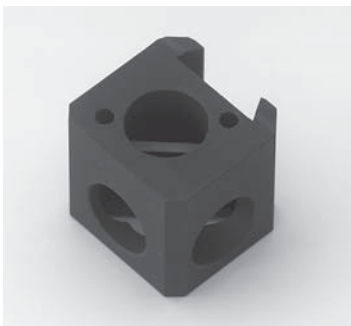



Caution!

Never look directly into the beam path!
When switching to the BF or Smith reflectors, there is a danger of being glared!



Caution!

Light sources pose a potential irradiation risk (glare, UV-radiation, IR-radiation).

For the 106z lamp housing, the direct filament image (for halogen lamps) or direct arc image (for gas discharge lamps), and its mirror image are focused separately and adjusted to each other.

On the left side of the microscope, there is an adjustment window (1.14, p. 16) for mapping the light source.

While observing the light source in the adjustment window, the lamp is adjusted as follows:

Fig. 53 106 z lamp housing

- 1 Lamp height adjustment
- 2,4 Mirror image height and side adjustment
- 3 Focusing the reflector
- 5 Lamp side adjustment
- 6 Collector (focusing of the lamp image)

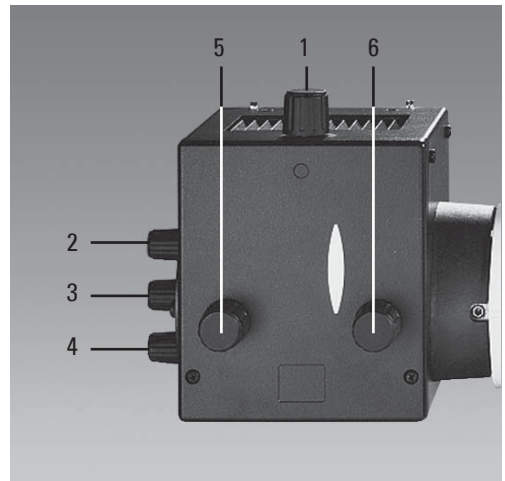

Centering the 12 V 100 W Halogen Lamp

- In the adjustment window, you see the direct filament image and the mirror image, which in most cases are not aligned.
- Focus the direct filament image with the collector (53.6).
- Use the adjusting buttons on the rear side of the lamp housing (53.2, 53.4) to pivot the lamp filament's mirror image to the side or completely out of the beam path. The lamp filament's focused image remains visible (Fig. 54).
- Adjust the direct filament image using the adjusting knobs (53.1) and (46.5) so that the centering surface is halfway covered (Fig. 55).
- Then pivot the lamp filament's mirror image with the adjusting knobs (53.2 and 4), and focus it using the reflector (53.3).
- Align the mirror image symmetrically to the filament image (Fig. 56). To do so, use the adjusting knobs (53.2) and (53.4) again.
- Defocus the image with the collector head (53.6) until the filament image and mirror image are no longer recognizable and the image is homogeneously illuminated.
- Exchange the reflector cube for lamp adjustment for the original filter cube.

Note:

Turn off the microscope before exchanging the reflector cube.

Fig. 54 Direct lamp filament image focused, but not centered
(in reality, the image is less focused)

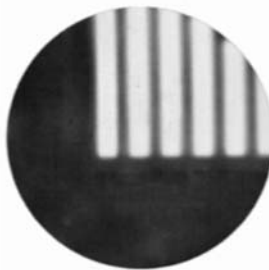

Fig. 55 Direct lamp filament image in target position
(in reality, the image is less focused)

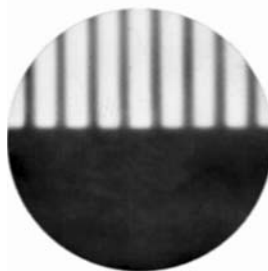
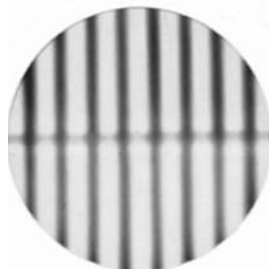

Fig. 56 Direct lamp filament image and mirror image in target position
(in reality, the image is less focused)



Centering the Hg 50 W mercury lamp

- In the adjustment window, you see the direct arc image and the mirror image, which in most cases are not aligned.
- Focus the direct image with the collector (53.6).
- Use the adjusting buttons on the rear side of the lamp housing (53.2,53.4) to pivot the arc's mirror image to the side or completely out of the beam path. The lamp filament's focused image remains visible (Fig. 57).
- Use the adjusting buttons (53.1) and (53.5) to place the direct arc image right or left on an imaginary center line of the centering plane (Fig. 58).
- Then pivot the arc's mirror image with the adjusting knobs (53.2 and 4) and focus it using the reflector (53.3).
- Use the adjusting knobs (53.2 and 4) to orient the mirror image symmetrically to the direct image (Fig. 59).
- Defocus the image with the collector knob (53.6) until the arc image and mirror image are no longer recognizable and the image is homogeneously illuminated.
- Exchange the reflector cube for lamp adjustment for the original filter cube.

Fig. 57 Direct arc image focused but decentered (in reality, the image is less focused)

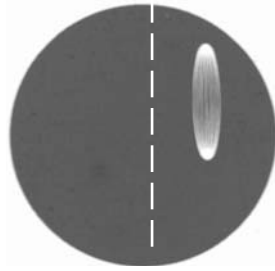

Fig. 58 Direct arc image in target position (in reality, the image is less focused)

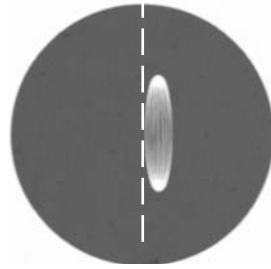
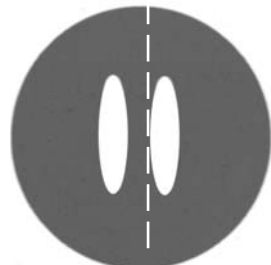

Fig. 59 Direct arc image and mirror image in target position (in reality, the image is less focused)



Centering the Hg 100 W and Xe 75 W mercury lamps

- In the adjustment window, you see the direct arc image and the mirror image, which in most cases are not aligned.
- Focus the direct image with the collector (53.6).
- Use the adjusting buttons to pivot the arc's mirror image on the rear side of the lamp housing (53.2,53.4) to the side or completely out of the beam path. The arc's focused image remains visible (Fig. 60).
- Use the adjusting buttons (53.1 and 5) to place the direct arc image in the middle of the centering plane, whereby the bright tip of the arc, the focal spot, should lie slightly outside the center (Fig. 61).
- Then pivot the arc's mirror image with the adjusting knobs (53.2) and (53.4) and focus it using the reflector (53.3).
- Use the adjusting knobs (53.2 and 4) to orient the mirror image symmetrically to the direct image (Fig. 62).
The V-shaped irradiation of the direct image and mirror image arcs can be superimposed.



Caution!

The bright tips of the arcs, the focal spots, must never be projected onto each other, as this results in a danger of explosion by overheating.

Fig. 60 Direct arc image focused but not centered (in reality, the image is less focused)

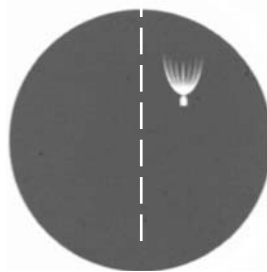

Fig. 61 Direct arc image in target position (in reality, the image is less focused)

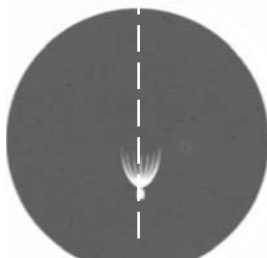
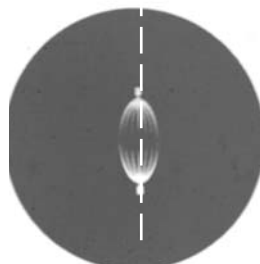

Fig. 62 Direct arc image and mirror image in target position (in reality, the image is less focused)





Caution:

In older lamps, the structure of the arc is no longer clearly recognizable. The image is then more like that of a HG 50 lamp. The image and mirror image can no longer be superimposed exactly. In this case, align both images.

- Using the collector, defocus the image with the knob (53.6) until the arc image and mirror image are no longer recognizable and the image is homogeneously illuminated.
- Exchange the reflector cube for lamp adjustment for the original filter cube.

Note:

Turn off the microscope before exchanging the reflector cube.

8. Operation

8.1 Switching on

When using a gas discharge lamp, the ebq 100 external supply unit must be turned on separately (63.1).

Switch on the Leica CTR6000 Electronics Box at the on/off switch (64.1). When in operation, the pilot lamp will light up green (64.2).



Note:

If you have connected a PC, please switch on the electronics box first and the computer afterwards.

All motorized components will run through an initializing phase.



Note:

If initializing failed (“InitError” on the LeicaScreen), please see chapter “Trouble Shooting”, → p. 80.

Fig. 63 Front view of the ebq 100 supply unit

- 1 Power switch
- 2 Lamp status

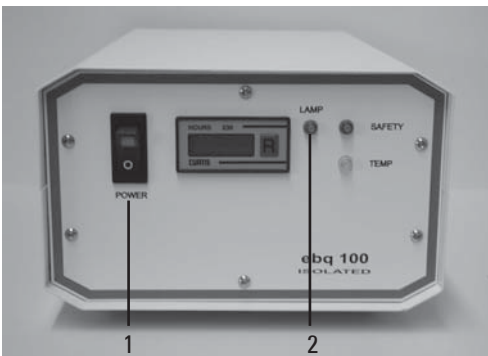

Fig. 64

- Front view of the Leica CTR6000 box
- 1 On/off switch
 - 2 Pilot lamp



8. Operation

During initialization, the stage will move to a pre-set position. The stage is lowered. The motorized tube will be set to the 100% VIS position. All most recently used settings will be recalled.



Caution:

The focus position (DM6000 B only) and the lower threshold will also be stored when switching off the microscope.

After the initialization is completed, the status menu of the LeicaScreen (Fig. 65) shows the current microscope setting.











Note: (Reset-Function)

The microscope can be reset to the default settings:

- When the microscope is switched off, press all 3 variable function keys on the left stand section.
- Switch on the stand.
- Hold the keys pressed down until initialization is completed.
- The standard information is shown in the LeicaScreen.
- Switch off the instrument and switch it on again. The settings are stored now.

Fig. 65 LeicaScreen, menu page 'Status'

	Status	Light	XYZ
	TL	BF	
	1.25x		1.0 x
	100 % - 0 %		
	Σ 12.5x		-987 μ m
			

8.2 Stages and Specimen Displacement

Specimen Displacement with SmartMove

The stage can be moved with the turning knobs (66.1, 66.2) at the remote control element SmartMove.

Setting the step sizes

There are two velocities for stage movement: **Fast** and **Precise**.

In the **Fast** mode, the velocity is the same for all objectives.

In the **Precise** mode, the velocity is adjusted to the objective in use.

Store and recall stage positions

With the Software Leica DMControl, module: DMOperation, different stage positions can be temporarily stored. Only the XY position is stored, not the current Z-position.

Apart from the loading position (Load), 5 additional stage positions can be temporarily stored. The current position is displayed on the XYZ menu of the LeicaScreen. When switching on the microscope, the stage will move to a defined starting position after initialization.

► Store temporarily /recall stage positions via

- Software Leica DMControl, module: DMOperation

► Switch between Fast and Precise via

- LeicaScreen, navigation item 
- Variable function keys at the stand and at the SmartMove
- Software Leica DMControl, module: DMOperation

Fig. 66 Remote Control Module SmartMove

- 1 Move in x-direction
- 2 Move in y-direction
- 3 Focus
- 4 Height adjustment
- 5 Variable function keys (factory pre-set)



8.3 Focusing

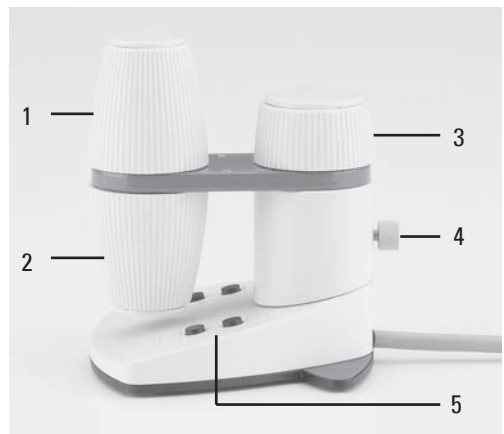

Note:

Parfocality has been learned in at the factory. Mounting the objectives, however, can change the values so that parfocality has to be learned in again.

We recommend to check parfocality before setting the thresholds. If necessary, it can be learned in with the Software Leica DMControl, module: Fine Tuning.

Image Focus

You can focus by using the turning knob (66.3) on the remote control element SmartMove.

Alternatively, you can use the focus wheels on both sides of the stand.

The current Z-position is displayed on the status page of the LeicaScreen. When switching on the microscope, before initialization the z-drive will automatically go to a position which is 3mm below the most recently used Z-position.

Setting thresholds

The lower threshold can be set with the LeicaScreen and with the Software Leica DMControl.

The **lower threshold** is the same for all objectives and can not be overrode.

Leica DM6000 B only:

An additional **focus position**, which can not be overrode, can be set. This position should be set for the DRY objective with the highest magnification. For all other objectives it will be set automatically, regarding parfocality and working distance.

▶ Setting thresholds via:

- ▶ LeicaScreen - navigation item 
- ▶ Software Leica DMControl, module: Fine Tuning

When the thresholds are set, this will be displayed on the LeicaScreen with the following pictograms:

- ▼ lower threshold not set
- ≡ lower threshold set
- ✕ focus position not set
- ✕ focus position not set

▶ Go to thresholds via:

- ▶ LeicaScreen - navigation item 
- ▶ Variable function keys at the stand and at the SmartMove
- ▶ Software Leica DMControl, module: Fine Tuning or DMOperation



Note:

When using the **UPPER Z** and **LOWER Z** keys to go to a threshold, the keys have to be pressed until the final position is reached.

There are two step sizes: **Fine** and **Coarse**.

In the **Fine** mode, the value is adjusted to the objective in use. The values are pre-defined. The settings can be changed with the Software Leica DMControl, module: Fine Tuning.

In the **Coarse** mode, the value is the same for all objectives. Coarse represents the maximum velocity.



Note:

When you assign a certain step size to an objective, this does not only affect the Z-drive but also the stage-step size that is assigned to this objective when selecting the **Precise** mode.

► **Switch between Fine and Coarse via:**

- LeicaScreen - navigation item 
- Variable function keys at the stand and at the SmartMove
- Software Leica DMControl, module: DMOperation

8.4 Tubes



Note:

Close any unused tube openings, as otherwise stray light can interfere with observation.



Note:

Make sure that the connector cable is plugged in on the MBDT25+ motorized tube (67.1).

Adjusting the Viewing Distance

- Adjust the viewing distance of the eyepieces so that a congruent total image is seen (Fig. 67).

Adjusting the Viewing Angle

- For the AET22 and EDT22 ergotubes, the viewing angle can be adjusted by tilting the binocular viewer in the range of 5° - 32° (Fig. 68)

Fig. 67 Tube setting

- ↔ Personal eyebase settings
- 1 Motorized tube connection



8. Operation

Adjusting the Eyepiece Section to the Arm Length

- On the AET22 tube, the eyepieces can be extended up to 30 mm (Fig. 68).



Beam Splitting in Photo Tubes

EDT22 tube:

The beam splitting between the observation and documentation outputs has a definite presetting (50:50).

BDT25+ tube:

The beam splitting is set manually by pulling out a control bar.

Control Bar		Observation	Photo
VIS		100 %	0 %
50/50		50 %	50 %
PHOTO		0 %	100 %

MBDT25+ tube:

This tube is similar to the documentation tube BDT25+, but it is motorized.

The control positions are displayed on the status page of the LeicaScreen.

After switching on, the position 100%VIS is set automatically.

Fig. 68 AET22 tube individual adjustments

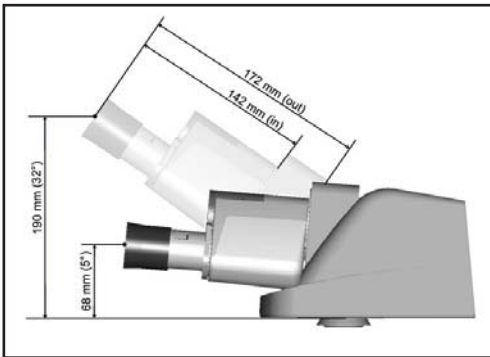



Key	Observation	Photo
VIS	100 %	0 %
50/50	50 %	50 %
PHOTO	0 %	100 %

▶ Select beam splitting via:

- ▶ LeicaScreen - navigation item 
- ▶ Variable function keys at the stand
- ▶ Software Leica DMControl - Modul: DMOperation

HC L 2TU tube:

The beam splitting is set manually by pulling out a control bar.

Control Bar		Observation	Photo
VIS		100 %	0 %
PHOTO		110 %	100 %



Note:

When using a dual-port, the beam splitting between the two cameras is set at 50:50 by default.

Fig. 69 BDT25+ tube with digital camera

1 Control bar



8.5 Eyepieces



Note:

The eyepiece's aperture protector must be removed or at least folded back, during microscopy while wearing eyeglasses. We recommend to take off glasses with bifocal or progressive-addition lenses when working with the microscope.

- For the adjustable tubes with documentation output, choose the 100% VIS position.

Eyepieces with Inlaid Reticle

- Focus the reticle by adjusting the eyelens.
- Focus on the object through this eyepiece.
- Then, close that eye and focus on the specimen by adjusting only the second ocular.

Correction for Vision Problems

- With your right eye, look through the right eyepiece and bring the specimen into sharp focus.
- Then, with your left eye, view the same specimen and rotate the left eyepiece tube until the object is brought into sharp focus. This does not affect the Z-position.



Note:

For eyepieces that are not included in delivery, we recommend to learn them in with the Software Leica DMControl, module: Configuration. This ensures that the information about total magnification on the LeicaScreen is correct.

8.6 Objectives

Selecting objectives

Objectives can be selected and rotated into the beam path via motorized functions, by pressing the variable function keys at the stand or at the SmartMove. They can also be selected manually. In this case be sure that the nosepiece turret locks into place.

The objective's position in the turret is factory-set and must be adhered to while screwing in the objectives (see Objective Assembly → p. 24)

When you rotate the objective into position, the microscope automatically recalls:

- the optimal setting for the field diaphragm
- the optimal setting for the aperture diaphragm
- the settings for light intensity for the chosen contrast method.

The objective magnification and the total magnification appear in the LeicaScreen → p. 58.

8. Operation

- Start with a small level of magnification. Then switch to the next higher objective.
- For **immersion objectives** use the appropriate immersion medium.
OIL: only use optical immersion oil according to DIN/ISO standards.
Cleaning → p. 81
W: Water immersion.
IMM: Universal objective for water, glycerol, oil immersion.



Caution!

Follow safety data sheet for immersion oil!

Changing the operation mode DRY or IMM (Immersion)

Each objective belongs to one of the following categories:

- 1) Dry objectives (DRY)
- 2) Immersion objectives (IMM)



Note:

It is possible to assign one objective to both operation modes, especially with dry objectives with >2mm working distance. The setting can be changed with Software Leica DMControl, module: Fine Tuning.

Changing the operation mode

- First select the operation mode (IMM or DRY) on the LeicaScreen, navigation item . The operation mode can also be selected with the Software Leica DMControl.
- The stage is lowered by 3mm. This enables you to apply the immersion oil when changing from dry to immersion objectives. In the reverse case, the oil can be removed. The current objective remains in the beam path.
- Now press the button for the objective you want to select. You can also press the gray button for the currently activated objective. The objective will be rotated into the beam path.

▶ Selecting objectives via:

- ▶ LeicaScreen - navigation item 
- ▶ Variable function keys at the stand and at the SmartMove
- ▶ Software Leica DMControl, module: DMOperation
- ▶ Manual operation is possible

**Note:**

If one of the buttons for changing the operation mode (DRY or IMM) is pressed by mistake, the previous mode can be reactivated by pressing the correct button. The stage will not be lowered again. The button for the current objective, however, will remain gray and has to be pressed again.

**Note:**

When retrofitting objectives, they have to be learned in with the Software Leica DMControl, module: configuration. Afterwards, parfocality should also be learned in again.

**Note:**

For lockable immersion objectives lock these by pushing the front part upwards until it stops (approx. 2 mm). Then, after a gentle turning motion to the right, the objective is locked (Fig. 71).

For objectives with corrective mounts turn the knurl to adjust the objective to the thickness of the cover glass.

► **Changing the operation mode via:**

- LeicaScreen - navigation item 
- Variable function keys at the stand and at the SmartMove
- Software Leica DMControl, module: DMOperation

Fig. 70 Immersion objective (released)

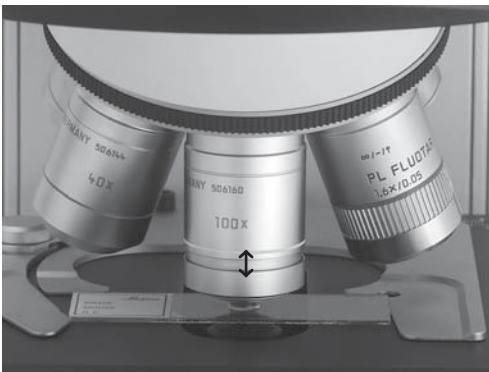

Fig. 71 Immersion objective (locked)



8. Operation

8.7 Magnification Changer

Optionally, a coded magnification changer can be used, which is manually operated.

On the knurled ring (72.1), the following magnification factors can be set:

Leica DM6000 B	Leica DM6000 M
1x	1x
1,25x	1,5x
1,6x	2x

The selected factor is indicated in the LeicaScreen or in the corresponding window of the Leica DMControl software and included in the total magnification.

Fig. 72 Magnification changer
1 Knurled wheel

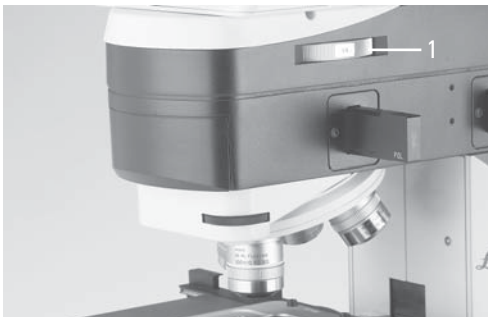

8.8 Light Sources

- The brightness is set using the function keys (73.5). Then, the **INT** function keys are assigned to the currently active axis for transmitted light (TL) or incident light (IL).
- For TL and IL:
Settings can be made either in large or small increments. Pushing both **INT** buttons simultaneously switches between coarse and fine setting. The display on the LeicaScreen, menu page 'Light' (fig. 74), changes accordingly.
Coarse adjustment: 0-20
Fine adjustment: 0-255
- The light intensity is set and stored individually for each objective and each contrast method.
- For FLUO: The brightness is set in 5 fixed steps
100% / 55% / 30% / 17% / 10%
(FIM=Fluorescence Intensity Manager)

Fig. 73 Control panel

- 1 Variable function keys
(also at the right side of the stand)
- 2 Aperture diaphragm
- 3 Transmitted light/incident light
- 4 Field diaphragm
- 5 Light intensity

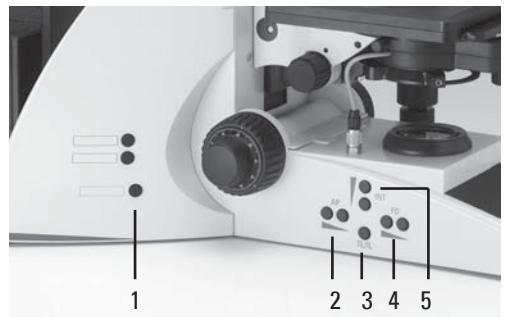

► **Light adjustment via:**

- Fixed function keys at the stand
- Variable function keys at the stand and at the SmartMove
- Software Leica DMControl, module: DMOperation

8.9 Aperture Diaphragm and Field Diaphragm

Both diaphragms are already factory-set to the optimum setting for the current objective and contrasting method.

- The **AP** (73.2) keys for the aperture diaphragm and the **FD** keys (73.4) for the field diaphragm may be used to change each diaphragm's setting at any time. The display on the LeicaScreen, menu page 'Light' (Fig. 74), changes accordingly.



Caution:

When doing so, old values are overwritten and the new values are stored!







- The function keys are always assigned to the currently active axis for transmitted light (TL) or incident light (IL).



Caution:

While using **PH** or **DF** the aperture diaphragm is completely opened and locked.

Fig. 74 LeicaScreen, menu page 'Light'

	Status	Light	XYZ
	Intensity		3
	Field		20
	Aperture		20
			
	1.25x	TL BF	

► **Adjust diaphragms via:**

- Fixed function keys at the stand
- Variable function keys at the stand and at the SmartMove
- Software Leica DMControl, module: DMOperation

9. Contrasting Methods for Leica DM6000 B

All contrasting methods can be selected and operated via the LeicaScreen, the variable function knobs and the Software Leica DMControl. Excluded from this principle are only methods which include components that have to be operated manually (e.g. systems with manual polarizer).

The following procedure describes the operation via function keys at the stand. For operation via LeicaScreen and Software, please see separate operation manuals.

9.1 Transmitted Light

9.1.1 Bright Field (TL)



Note:

If all positions at the filter turret are occupied, the filter cube "A" can be exchanged for "A-TL" with the Software Leica DMControl, module: Configuration. TL contrasting methods are now possible.

- Switch to the transmitted light axis (TL) by pushing the **TL/IL** button.
- Select the **BF** (bright field) contrast method. Do so by pressing the **BF** variable key. Alternatively: Press the **CHANGE TL**  variable key. (For key occupation please see "Identification Sheet".)
The display of the LeicaScreen, menu page 'Status' indicates **BF**.
An empty position or the "A-TL" filter cube are selected automatically.
- Insert a transmitted light specimen.
- Select an appropriate objective.
- Focus on the image with the turning knob on the SmartMove or with the focus wheel and adjust the illumination with the **INT**-keys.

9.1.2 Phase Contrast

- Switch to the transmitted light axis (TL) by pushing the **TL/IL** button.
- Select the **PH** contrast (phase contrast) method. Do so by pressing the **PH** variable key. Alternatively: Press the **CHANGE TL**  variable key. (For key occupation please see “Identification Sheet”.) The display of the LeicaScreen, menu page ‘Status’ indicates **PH**.
- Insert a transmitted light specimen.
- Select an appropriate objective. Objectives that are suitable for phase contrast are engraved with PH.
- Focus on the image with the turning knob on the SmartMove or with the focus wheel and adjust the illumination with the **INT**-keys.



Notes:

- The microscope automatically selects the correct light ring in the condenser.
- When selecting the phase contrast method, the aperture diaphragm is opened completely and can not be adjusted.

9.1.3 Dark Field (TL)

- Switch to the transmitted light axis (TL) by pushing the **TL/IL** button.
- Select the **DF** (dark field) contrast method. Do so by pressing the **DF** variable key. Alternatively: Press the **CHANGE TL**  variable key. (For key occupation please see “Identification Sheet”.) The display of the LeicaScreen, menu page ‘Status’ indicates **DF**. The dark field ring (dark field stop) is set automatically.
- Insert a transmitted light specimen.
- Select an appropriate objective.
- Focus on the image with the turning knob on the SmartMove or with the focus wheel and adjust the illumination with the **INT**-keys.



Notes:

- The maximum objective aperture which may be used for dark field is **0.75**. When an invalid objective is selected, the corresponding button on the LeicaScreen flashes.
- The microscope automatically selects the correct light ring in the condenser.
- When selecting the dark field method, the aperture diaphragm is opened completely and can not be adjusted.

9.1.4 Polarization (TL)

- Switch to the transmitted light axis (TL) by pushing the **TL/IL** button.
- Select the **POL** (polarization) contrast method. Do so by pressing the **POL** variable key. Alternatively: Press the **CHANGE TL**  variable key. (For key occupation please see “Identification Sheet”.)
The display of the LeicaScreen, menu page ‘Status’ indicates **POL**.

Manual procedure:

- Turn the polarizer on the underside of the condenser in the light path (Fig. 75). Make sure that the red index point on the front of the polarizer is aligned with 0.
- Insert the analyzer into the left side of the stand (76.1).

- Bring the polarizer and analyzer into cross position until they reach maximum darkness.
- Insert a specimen and select an appropriate objective.

Motorized procedure:

- After selecting the POL contrast method, the condenser automatically switches to the position of the polarizer. The analyzer cube is also automatically brought into the light path.

Combined procedure:

- For the Leica DM6000 B microscope, it is possible to combine mechanical and motorized components.

Fig. 75 Swivel in polarizer

1 Polarizer

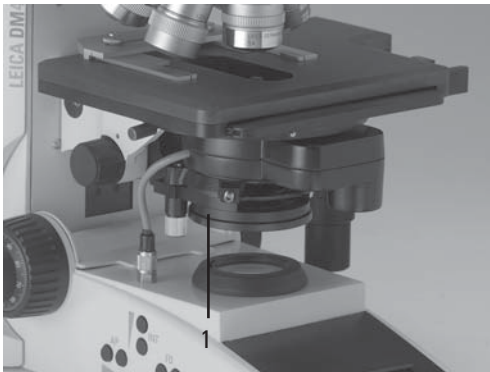
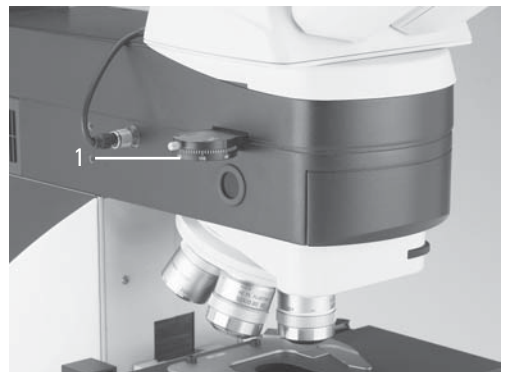



Fig. 76 Insert analyzer

1 Analyzer



9.1.5 Differential Interference Contrast (TL)

- Switch to the transmitted light axis (TL) by pushing the **TL/IL** button.
- Insert a specimen and select an appropriate objective.
- Select the **DIC** contrast method. Do so by pressing the **DIC** variable key. Alternatively: Press the **CHANGE TL**  variable key. (For key occupation please see “Identification Sheet”.) The display of the LeicaScreen, menu page ‘Status’ indicates **ICT**.
- The polarizer located in the condenser and the fitting condenser prism are automatically brought into the light path. The corresponding objective prism and the analyzer cube are also positioned automatically.
- For fine adjustment use the knurled wheel above the objective turret (77.1).

Alternatively:

- Manually rotate the polarizer on the underside of the condenser into the light path (Fig. 75).
- Likewise, manually insert the analyzer into the left side of the stand (Fig. 76). Objective and condenser prisms are automatically moved into the light path as well.
- For fine adjustment use the knurled wheel above the objective turret (77.1).

Fig. 77 DIC turret

1 Knurled wheel for fine focusing



9.2 Fluorescence

- Switch to the fluorescent light axis (FLUO) by pushing the **TL/IL** button.
- Insert a specimen and select an appropriate objective.
- The current fluorescence cube is indicated on the display of the LeicaScreen, menu page 'Status'.
- Closing the incident light shutter protects your specimen from fading.
Do so by pressing the **SHUTTER** variable key.
(For key occupation please see "Identification Sheet".)

The display of the LeicaScreen indicates the symbol:



Fig. 78 Inserting the Booster Lens



▶ Selecting the fluorescence filter cube:

- ▶ LeicaScreen - navigation item 
 - ▶ Variable function keys at the stand and at the SmartMove: **Cube CW** or **Cube CCW**
 - ▶ Software Leica DMControl, module: DMOperation
- Focus on the image with the turning knob on the SmartMove or with the focus wheel and adjust the illumination with the **INT**-keys.
 - The fluorescence intensity can be increased using the Booster Lens on the right side of the stand (Fig. 78). It is recommended to insert the Booster Lens into the front receptacle.
 - For multifuorescence, the use of an Excitation Manager is recommended. The Excitation Manager is inserted into the right side of the stand up to the last stop (Fig. 79). It is recommended to insert the Excitation Manager into the front receptacle.



Fig. 79 Inserting the Excitation Manager



9.3 Combi Mode

Depending on the configuration of your microscope, up to two combi modes are possible:

FLUO/PH and FLUO/DIC

- Select the combi mode.
Do so by pressing the **COMBI**  variable key.
Alternatively: Press the **CHANGE COMBI**  variable key.
(For key occupation please see "Identification Sheet".)
The display of the LeicaScreen changes accordingly.
- Insert a specimen and select an appropriate objective.
- The required fluorescence cube can be selected with the variable function keys.
- The illumination settings for the fluorescence axis and the TL axis can be adjusted separately.
- To switch between the axes, press the function key **TL/IL** at the stand. The display on the LeicaScreen changes accordingly.

IL > TL FL > PH

The TL axis (TL-PH) is activated.

IL < TL FL < PH

The Fluorescence axis is activated.



Note:

For FLUO/DIC the manual analyzer (81.1) has to be used, as described in chapter 10.1.4, → p. 76.

10. Contrasting Methods for Leica DM6000 M

All contrasting methods can be selected and operated via the LeicaScreen, the variable function knobs and the Software Leica DMControl. Excluded from this principle are only methods which include components that have to be operated manually (e.g. systems with manual polarizer).

The following procedure describes the operation via function keys at the stand. For operation via LeicaScreen and Software, please see separate operation manuals.

10.1 Incident Light

10.1.1 Bright Field (IL)

- Switch to the incident light axis (IL) by pushing the **TL/IL** button.
- Select the **BF** (bright field) contrast method. Do so by pressing the **BF** variable key. Alternatively: Press the **CHANGE RL**  variable key. (For key occupation please see “Identification Sheet”.)
The display of the LeicaScreen, menu page ‘Status’ indicates **BF**.
- Insert a specimen.
- Select an appropriate objective.
- Focus on the image with the turning knob on the SmartMove or with the focus wheel and adjust the illumination with the **INT**-keys.
The values for brightness are stored for each objective.

10.1.2 Dark Field (IL)

- Switch to the incident light axis (IL) by pushing the **TL/IL** button.
- Select the **DF** (dark field) contrast method. Do so by pressing the **DF** variable key. Alternatively: Press the **CHANGE RL**  variable key. (For key occupation please see “Identification Sheet”.)
The display of the LeicaScreen, menu page ‘Status’ indicates **DF**.
The DF reflector is turned into the beam path.
- Insert a specimen.
- Select an appropriate objective.
- Focus on the image with the turning knob on the SmartMove or with the focus wheel and adjust the illumination with the **INT**-keys.



Note:

When selecting the dark field method, the field diaphragm is opened completely and may not be adjusted.

10.1.3 Polarization (IL)

- Switch to the incident light axis (IL) by pushing the **TL/IL** button.
 - Select the **POL** (polarization) contrast method. Do so by pressing the **POL** variable key. Alternatively: Press the **CHANGE RL** variable key.
(For key occupation please see “Identification Sheet”.)
The display of the LeicaScreen, menu page ‘Status’ indicates **POL**.
- Automatic procedure:**
- The ICR filter cube is automatically brought into the light path.
- Manual procedure:**
- Rotate the appropriate polarizer (80.3) and the IC/P analyzer (81.1) on the stand manually into the light path. Also bring the polarizer and analyzer into cross position until they reach maximum darkness.
 - Insert a specimen and select an appropriate objective.

Fig. 80 Insert polarizer

- 1 Polarizer
- 2 Knurled wheel for fine focusing



Fig. 81 Insert analyzer

- 1 Analyzer

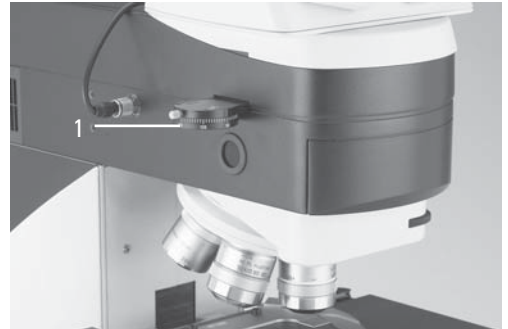

10.1.4 Interference Contrast (IL)

- Switch to the incident light axis (IL) by pushing the **TL/IL** button.
- Insert a specimen and select an appropriate objective.
- Select the **DIC** contrast method. Do so by pressing the **DIC** variable key. Alternatively: Press the **CHANGE RL**  variable key. (For key occupation please see “Identification Sheet”.) The display of the LeicaScreen, menu page ‘Status’ indicates **DIC**.
- The ICR filter cube (containing polarizer and analyzer) is automatically brought into the beam path on the incident light axis.

Alternatively:

- Rotate the ICR polarizer (80.1) and the IC/P analyzer (81.1) on the stand manually into the light path.
- Objectives and condenser prisms are swung into the beam path automatically.
- For fine adjustment, rotate the knurled wheel (80.2).

10.1.5 Fluorescence

- Switch to the incident light axis (IL) with the function key **TL/IL**
- Insert a specimen and select an appropriate objective.
- If the last used IL-mode was fluorescence, the current fluo filter cube is displayed on the LeicaScreen.

▶ Selecting the fluorescence filter cube:

- ▶ LeicaScreen - navigation item 
- ▶ Variable function keys at the stand and at the SmartMove: **Cube CW** or **Cube CCW**
- ▶ Software Leica DMControl, module: DMOperation

- Focus on the image with the turning knob on the SmartMove or with the focus wheel.

10.2 Transmitted Light

10.2.1 Bright Field (TL)

- Switch to the transmitted light axis by pushing the **TL/IL** button.
- Select the **BF** (bright field) contrast method. Do so by pressing the **BF TL** variable key. (For key occupation please see "Identification Sheet".)
The display of the LeicaScreen, menu page 'Status' indicates **BF TL**.
- Insert a transmitted light specimen.
- Select an appropriate objective.
- Focus on the image with the turning knob on the SmartMove or with the focus wheel and adjust the illumination with the **INT**-keys.

10.2.2 Polarization (TL)

- Switch to the transmitted light axis (TL) by pushing the **TL/IL** button.
- Select the **POL** (polarization) contrast method. Do so by pressing the **POL** variable key. Alternatively: Press the **CHANGE TL**  variable key. (For key occupation please see "Identification Sheet".)
The display of the LeicaScreen, menu page 'Status' indicates **POL**.

Manual procedure:

- Turn the polarizer on the underside of the condenser in the light path (Fig. 75). Make sure that the red index point on the front of the polarizer is aligned with 0.
- Insert the analyzer into the left side of the stand (76.1).
- Bring the polarizer and analyzer into cross position until they reach maximum darkness.
- Insert a specimen and select a low-magnification objective.

Motorized procedure:

- After selecting the **POL** contrast method, the condenser automatically switches to the position of the polarizer. The analyzer cube is also automatically brought into the light path.

Combined procedure:

- For the Leica DM6000 M microscope, it is possible to combine mechanical and motorized components.

11. Trouble Shooting

Problem	Cause/Remedy
Stand	
The microscope does not respond.	<ul style="list-style-type: none">▶ Make sure that voltage is impressed.▶ Make sure that the CTR6000 electronics box is connected to the power supply.▶ Check the cable connections.▶ Inform service technician to change the fuses.
Illumination	
The image is completely dark.	<ul style="list-style-type: none">▶ Open the shutter (→ p. 84).▶ Check the connection of the lamp houses to the microscope. Transmitted axis: \triangle Reflected (Fluo) axis: ∇▶ Make sure that the lamps are connected to the power supply and that they are not defect.▶ Inform service technician to change the fuses of the ebq 100.
The image is unevenly or not uniformly illuminated.	<ul style="list-style-type: none">▶ Remove all unneeded filters from the light path.▶ Center the lamp (→ p. 51ff).▶ Replace the old lamp (→ p. 24ff).
The illumination "flickers."	<ul style="list-style-type: none">▶ Be sure that there is no loose connection at the power supply.▶ Replace the old lamp (→ p. 24ff).
The lamp does not illuminate immediately upon being switched on.	<ul style="list-style-type: none">▶ The ebq 100 must be switched-on repeatedly.▶ Hot Hg lamps should cool down before switching on again.

Problem	Cause/Remedy
Bright Field	
The specimen can not be brought into focus.	<ul style="list-style-type: none"> ▶ Use the correct immersion medium. ▶ Lay the specimen with the cover glass towards the top. ▶ Make sure that the cover glass thickness is correct and that it suits the indication on the objective.
Dark Field	
No definite DF contrast is possible.	<ul style="list-style-type: none"> ▶ Be sure that a DF objective is being used. ▶ The objective aperture setting is too high (maximum 0.75). If necessary, reduce the objective aperture using the iris diaphragm on the objective. ▶ Check the condenser centering.
The image is unevenly or not uniformly illuminated.	<ul style="list-style-type: none"> ▶ The magnification is too weak. Use a higher magnification.
Undesirable stray light	<ul style="list-style-type: none"> ▶ Clean the specimen and neighboring lenses (→ p. 81).
Phase contrast	
No phase contrast is possible.	<ul style="list-style-type: none"> ▶ The specimen is too thick. ▶ The cover glass is not placed evenly. ▶ Check the centering of the light rings (→ p. 49).

11. Trouble Shooting

Problem	Cause/Remedy
Polarization	
No polarization contrast is possible.	<ul style="list-style-type: none">▶ Bring the polarizer and analyzer into cross position until they reach maximum darkness (without specimen) (→ p. 70, 75).
Fluorescence	
The image is completely dark (no fluorescence).	<ul style="list-style-type: none">▶ Open the shutter (→ p. 72).▶ Select the incident light axis (IL) (→ p. 45).▶ Check the antigen-antibody combination.▶ Insert a new lamp (→ p. 26f).
The fluorescence is too weak.	<ul style="list-style-type: none">▶ Insert the Booster Lens (→ p. 35).▶ Center the lamp (→ p. 51ff).▶ Insert a new lamp (→ p. 26f).
LeicaScreen	
Init Error!	<ul style="list-style-type: none">▶ Check the cable connections.▶ Check if the front cover of the filter turret is locked in place.▶ Check the currently used objectives, filter cubes, etc.▶ Restart the microscope.

12. Care of the Microscope



Caution!

Unplug the power supply before performing cleaning and maintenance work!
Protect electrical components from moisture!

Microscopes in warm and warm-damp climatic zones require special care in order to prevent fungus contamination.

The microscope should be cleaned after each use, and the microscope optics should be kept strictly clean.

12.1 Dust Cover



Note:

To protect against dust, cover the microscope and accessories with the dust cover after each use.



Caution!

Let lamps cool down before covering the stand with a dust cover. The dust cover is not heat-resistant. In addition condensation water may occur.

12.2 Cleaning



Caution:

Residual fiber and dust can create unwanted background fluorescence.

Cleaning Coated Parts

Dust and loose dirt particles can be removed with a soft brush or lint-free cotton cloth.

Clinging dirt can be cleaned with all commercially available water solutions, benzine or alcohol.

For cleaning coated parts, use a linen or leather cloth that is moistened with one of these substances.



Caution:

Acetone, xylene or nitro-containing thinner can harm the microscope and thus may not be used.

Test cleaning solutions of unknown composition first on a less visible area of the unit. Be sure that coated or plastic surfaces do not become matted or etched.

Cleaning the Stage

Remove light-colored spots on the stage by rubbing with paraffin oil or acid-free Vaseline.

12. Care of the Microscope

Cleaning Glass Surfaces

Remove dust on glass surfaces with a fine, dry and fat-free hair brush, by blowing with a blow bag or vacuum suction.

Carefully remove stubborn dirt on glass surfaces with a clean cloth moistened with distilled water. If the dirt still can not be removed, use pure alcohol, chloroform or benzene.

Cleaning Objectives



Caution!

The objective may not be unscrewed during cleaning. If damage appears on inner surfaces, the objectives must be sent to your Leica subsidiary for repair. We also advise against cleaning the inside surfaces of the eyepieces.

The front lenses of objectives are cleaned as described under "Cleaning Glass Surfaces". The upper lens is cleaned by being blown off with a pneumatic pump.

Removing Immersion Oil



Caution!

Follow safety instructions for immersion oil!

First, wipe off the immersion oil with a clean cotton cloth, and then re-wipe the surface several times with ethyl alcohol.

12.3 Handling Acids and Bases

For examinations using acids or other aggressive chemicals, particular caution must be taken.

















Caution:

Be absolutely certain to prevent the optics and mechanical parts from coming into contact with these chemicals.

13. Essential Wear and Spare Parts

Order No. Material No.	Name	Used for
<u>Replacement Lamp</u>		
11 500 974	Halogen lamp 12 V 100 W	107/2 lamp housing
11 500 137	High-pressure mercury burner 50 W	106 z lamp housing
11 500 138	High-pressure mercury burner 100 W	106 z lamp housing
11 500 321	High-pressure mercury burner 100 W (103 W/2)	106 z lamp housing
11 500 139	High-pressure xenon burner 75 W	106 z lamp housing
<u>Screw cap for unused objective receptacles</u>		
020-422.570-000	Screw cap M 25	Objective turret
<u>Replacement eyecup (diaphragm protection) for HC PLAN eyepiece</u>		
021-500.017-005	HC PLAN eyecup	10x/25 eyepiece
021-264.520-018	HC PLAN eyecup	10x/22 eyepiece
021-264.520-018	HC PLAN eyecup	10x/20 eyepiece
<u>Immersion Oil conforming to DIN/ISO standards, fluorescence-free</u>		
11 513 787	10 ml	OIL and IMM objectives and oil condenser heads
11 513 522	100 ml	
11 513 788	500 ml	

14. Abbreviations and Pictograms

	Basic setting of microscope
	Contrasting method
	Magnification
	Documentation port
	Stage and focus settings
	LeicaScreen configuration
	Lower threshold not set
	Lower threshold set
	Focus position not set
	Focus position not set
	Transmitted light shutter open
	Transmitted light shutter closed
	Incident light shutter open
	Incident light shutter closed

AET	Advanced Ergo Tube
AP	Aperture diaphragm
BF	Bright field
COMBI	Combination contrast method
CUBE	Filter cube
DF	Darkfield
DIC	Differential interference contrast
FD	Field diaphragm
FLUO	Fluo axis (incident light)
ICR	Interference contrast (reflected light)
ICT	Interference contrast (transmitted light)
IL	Incident light (axis)
INT	Intensity
MBDT	Motorized Basic Documentation Tube
PH	Phase contrast
POL	Polarization
RL	Reflected light (axis)
TL	Transmitted light (axis)

15. Index

- Adjusting the light sources 51
- Allowable ambient conditions 19
- Ambient temperature 10
- Ambient conditions 19
- Analyzer 33, 70, 71, 75, 77
- Analyzer cube 70, 71, 77
- Aperture diaphragm 16, 67
- Beam splitting** 62
- Bright field 68, 74
- Booster Lens 35, 72
- Camera** 34
- Cleaning 81
- Cleaning objectives 82
- Combi mode 73
- Condenser connector 22
- Condenser 16, 22
- Condenser centering 47
- Condenser height adjuster 21, 22
- Condenser holder 22
- Connection to power supply 37
- Contrasting methods 12, 68, 74
- Dark field** 69, 74
- Dark field stop 69
- Defined function keys 45
- DIC prisms 33
- Differential interference contrast 71
- DMControl 14, 18
- Dual-port 34, 62
- Electrical safety** 10
- Electronics box CTR6000 10, 36
- Ergomodule 35
- Excitation Manager 35, 72
- Eyepiece 16, 63
- Field diaphragm** 16, 67
- Filter block exchanger 17
- Filter cube 31
- Filter cube ICR 75, 76
- FIM (Fluo Intensity Manager) 12, 66
- Fluorescence 72, 76
- Fluorescence intensity 72
- Focus finder 42
- Focusing 60
- Focusing telescope 49
- Focus position 60
- Function keys 45
- Gas discharge lamps** 28, 29
- Halogen lamp** 27, 53
- Hg 50 burner 29
- ICT/P transmitted light polarizer 32
- Identification Sheet 24, 31, 68f, 70f
- Immersion oil 64, 82
- Incident light axis 12
- Incident light nosepiece disc 31
- Incident light polarizers 32
- Incident light shutter 42
- Initialization 43, 58
- Interference contrast 76
- Intermediate systems 20
- Köhler illumination** 22, 46
- Lamp housing** 17
- Lamp housing 106 z 26, 51
- Lamp housing 107/2 25, 51
- Lamp housing receptacle 25, 27, 30
- LeicaScreen 43, 44
- Light intensity 66
- Light sources 51, 66
- Light sources (incident light axis) 26
- Light sources (transmitted light axis) 24
- Magnification changer** 66
- Mercury lamp Hg 50 W 54
- Mercury lamp Hg 100W /Xe 75W 55
- Mirror housing 35
- Motorized analyzer 33
- Motorized polarizer 33
- Objective aperture** 69
- Objectives 63
- Objective selection 63
- Objective turret 13, 16
- Object stage 21
- Operation mode 64
- Phase contrast** 50, 69
- Phase contrast rings (checking) 49
- Polarization 70, 75
- Polarizer 70, 71, 75, 77
- Polarizer L/ICR 32
- Polarizer R/ICR 32
- Polarizer R/P 32
- Reflector cube** 31
- Reflector cube for lamp adjustment 51
- Remote control module 46
- Reset function 39, 58
- Retention pin 32
- Rotating polarizer 32
- Shutter** 72
- SmartMove 46, 59
- Software Leica DMControl 14, 18
- Specimen displacement 59
- Specimen holder 21
- Stage positions 59
- Step sizes 59, 61
- Supply unit ebq 100 10, 30, 37, 57
- Switch transmitted/incident light 16
- Thresholds** 60
- Transmitted light and incident light analyzer 33
- Transmitted light axis 12
- Transmitted light filter 17
- Transmitted light shutter 41
- Variable function keys** 16, 17, 45, 46
- Viewing angle 61
- Viewing distance 61
- Vision problems 63
- Xe 75 burner** 29

16. EU Declaration of Conformity

We hereby declare that the device described below, both in its basic design and construction and in the version marked by us, conforms to the relevant safety- and health- related requirements of the appropriate EU directives.

This declaration shall cease to be valid if modifications are made to the device without our approval.

Product:	DM6000 B	Product:	DM6000 M
Model:	Microscope	Model:	Microscope
Identification No:	11888107, 11888087, 11888091, 11888131, 11888132	Identification No:	11888107, 11888083, 11888641
EU directives:	In vitro Diagnostic Directive: 98/79/EG	EU directives:	Low voltage: 73/23/EEC EMC: 89/336/EEC
Harmonised standards applied:	EN 55011 : 2003-08 EN 55022 : 2003-09 EN 61000-3-2 : 2001-12 EN 61000-3-3 : 2002-05 EN 61000-4-2 : 2001-12 EN 61000-4-3 : 2003-11 EN 61000-4-4 : 2002-07 EN 61000-4-5 : 2001-12 EN 61000-4-6 : 2001-12 EN 61000-4-8 : 2001-12 EN 61000-4-11: 2001-12 EN 61000-6-1 : 2002-08 EN 61000-6-3 : 2002-08 EN 61010-1 : 2002-08 EN 61010-2-101 : 2003-09	Harmonised standards applied:	EN 55011 : 2003-08 EN 55022 : 2003-09 EN 61000-3-2 : 2001-12 EN 61000-3-3 : 2002-05 EN 61000-4-2 : 2001-12 EN 61000-4-3 : 2003-11 EN 61000-4-4 : 2002-07 EN 61000-4-5 : 2001-12 EN 61000-4-6 : 2001-12 EN 61000-4-8 : 2001-12 EN 61000-4-11: 2001-12 EN 61000-6-2 : 2002-08 EN 61000-6-4 : 2002-08 EN 61010-1 : 2002-08

Wetzlar, 24.11.2003



Dr. L. Remer, Manager R&D

Wetzlar, 24.11.2003



Dr. L. Remer, Manager R&D