









260x280
GH-LR



260x280
SHI-LR

260x280 GH-LR

27x0,9

					
255	215	126	195	x	x
280x250	200x210	135x110	178x160	x	280x120

				
3x400V 50 Hz	0,9/1,4	35/70	2970x27x0,9	320

Lmin	Lmax	B	Hmin	Hmax	V
1645	1750	890	1360	1950	788

260x280 SHI-LR

27x0,9

					
255	215	126	195	x	x
280x250	200x210	135x110	178x160	x	280x120

				
3x400V 50 Hz	1,5	20-100	2970x27x0,9	420

L	B	Hmin	Hmax	V
1900	1050	1390	1850	795

STANDARD OPTION

GH-LR + SH-LR

260-CK

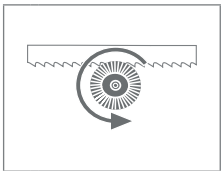

MINI LUBE 27-34

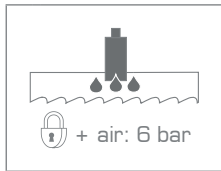

LASER LINE

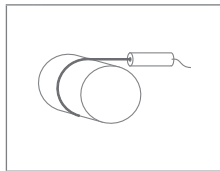

WGUN1

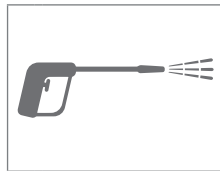

R 290

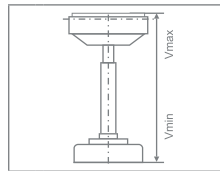

	S (mm)	Vmin (mm)	Vmax (mm)
R	290	760	980

GH-LR

260-M2V

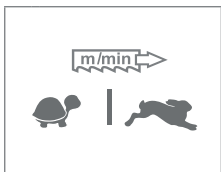

260-F

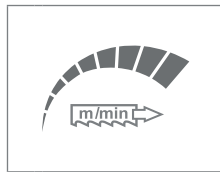

260-DPP

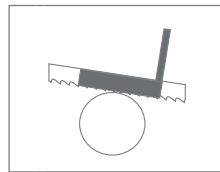

PEGAS-BRP

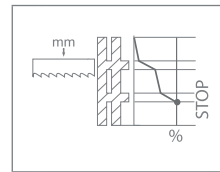

260-HP

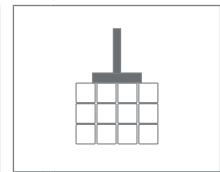

260-RTS

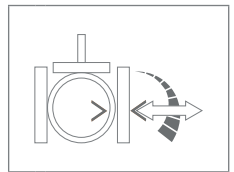

LIGHT L1

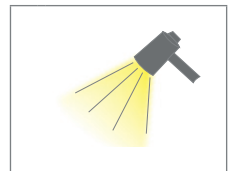

RB 200



RBS 200/290 +RB

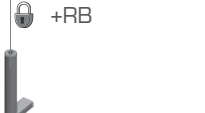

RHS 290 +RBS+RB



OZD 1000

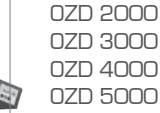

OZD 2000
OZD 3000
OZD 4000
OZD 5000
OZD 6000

OZ 1000

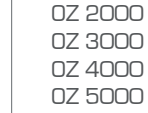

OZ 2000
OZ 3000
OZ 4000
OZ 5000
OZ 6000

OZ 0000

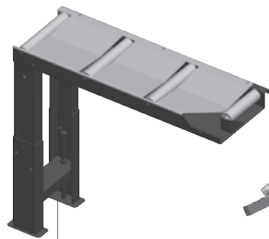

230-RDP

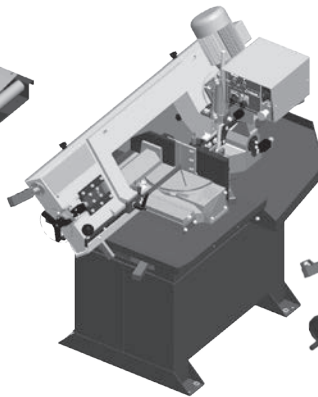

RD VR-290



230-RDZ



230-OZM



RDN

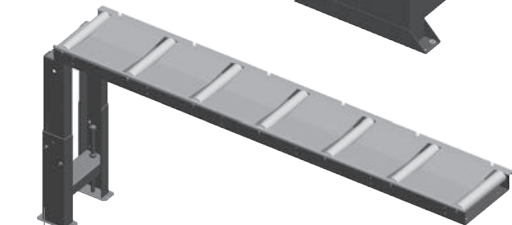

RD 2000/290

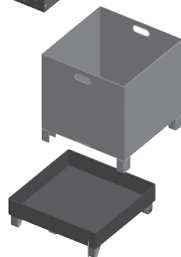

BOX-PCS

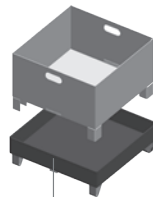

BOX-TRI



BOX-TAH

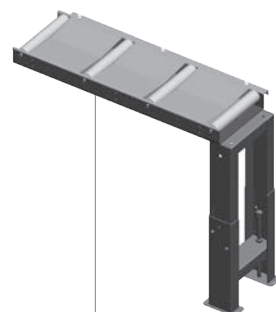

RD 1000/290



CONTROL PANEL: MITSUBISHI

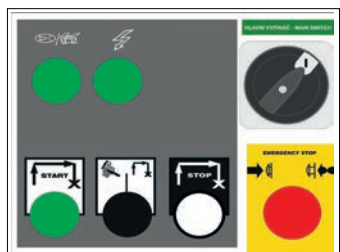

CONTROL PANEL: GH-LR

260x280 GH-LR

260x280 SHI-LR

- výrobce si vyhrazuje právo provádět změny technických údajů, technické údaje odpovídají 1.1.2024 / producer has the right to make changes of technical data, technical data are valid on 1.1.2024

- pila na fotografii není vždy v základním provedení, uvedené rozměry odpovídají stroji v základním provedení / the machine in the picture is not always in the basic version, mentioned diameters are for machine in basic version

* doporučená hodnota. Při překročení doporučeného maximálního průměru není možné garantovat výkon pilového pásu!

/ recommended value. The blade performance cannot be guaranteed when the recommended diameter is exceeded!

☒ - řezání svazků bez horního přitlaku / cutting of the bundle without top clamping



PEGAS - GONDA s.r.o.
Čs.armády 322, 684 01 Slavkov u Brna,
CZECH REPUBLIC

www.pegas-gonda.cz
00420-544 221 125 (126) | pegas@gonda.cz