

# GLOBAL and Leitz Reference CMMs

Targeted configurations  
for specific application requirements





**Flexibility**

# GLOBAL and Leitz Reference CMMs

## Perfected for the measurement task at hand

With consumers demanding increasingly customised products on shorter lead times than ever before, productivity is a key competitive driver in manufacturing. To remain ahead of the competition, manufacturers need technologies that improve efficiency in their critical workflows. Metrology equipment is no exception and must contribute to efficient production without rejects.

To address each manufacturer's requirements, Hexagon offers targeted CMM configurations optimised for specific inspection challenges, enabling highly efficient measurement across a broad range of applications.

Hexagon's metrology capabilities are built upon a deep technology heritage, a strong commitment to innovation and close customer collaboration. To ensure manufacturer competitiveness now and in the future, the GLOBAL and Leitz Reference series bring this experience and technology leadership into a versatile range of machines, reinforced by a uniquely broad portfolio of sensors, software, accessories, collaborative technologies and services.

### Contents

- Introduction	3
- The identity of Hexagon's CMMs	4   5
- GLOBAL and Leitz Reference CMMs	6   7
- GLOBAL Touch+	8   9
- GLOBAL Scan+	10   11
- GLOBAL Optics	12   13
- GLOBAL Speed	14   15
- Leitz Reference Precision	16   17
- Leitz Reference Flexibility	18   19
- Options and accessories	20   23
- Comprehensive software	24   25
- Asset management	26
- Greener metrology	26
- Service and support	27

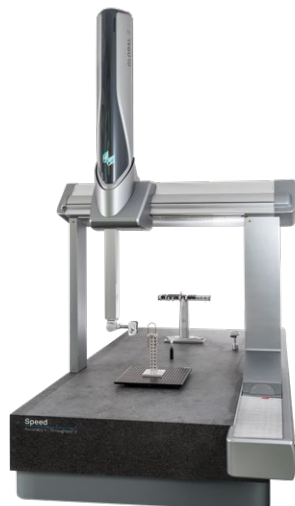
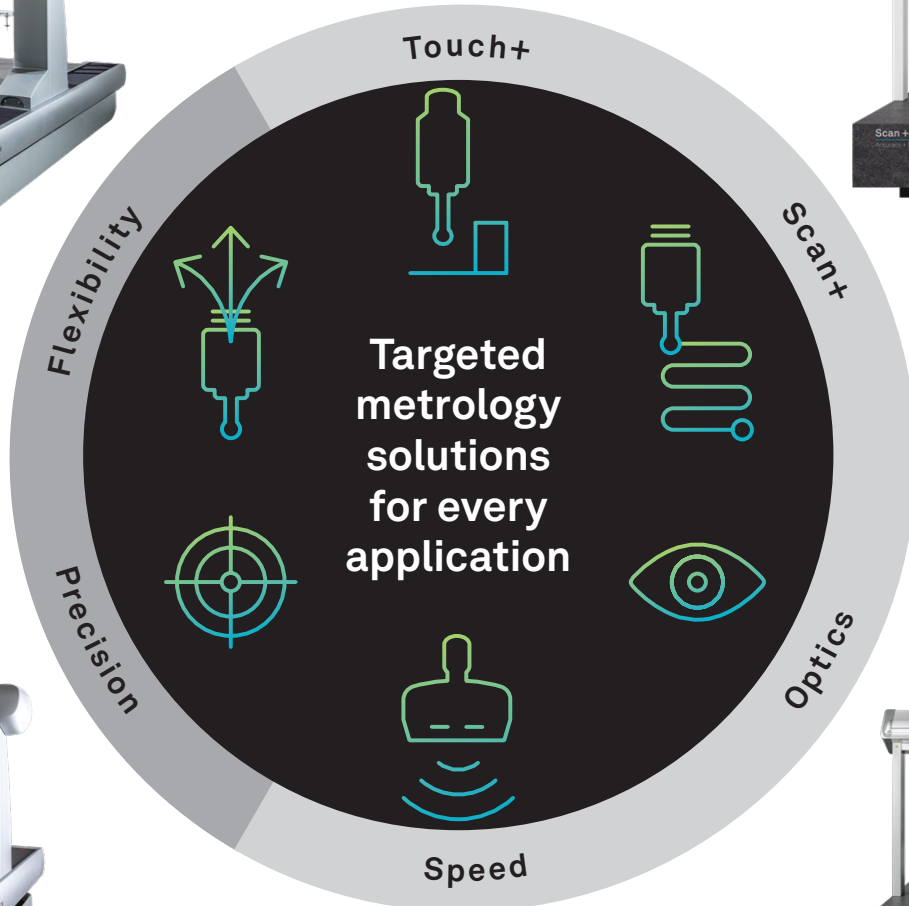

# Making measurement systems a competitive advantage

Built upon a connected portfolio of advanced technologies, GLOBAL and Leitz Reference CMMs cover virtually all 3D measurement applications establishing them among the market's most capable and versatile metrology devices.

Hexagon has configured these metrology capabilities into six base CMM models, each forming a complete solution to serve specific inspection requirements in terms of throughput, accuracy, reliability, flexibility and automation, no matter the size or weight of your part.

## **Configured for specific needs, adaptable when requirements change**

The six models – Touch+, Scan+, Optics, Speed, Precision and Flexibility – are each configured for measurement tasks typical in their corresponding application class.

And because inspection requirements widely differ and usually change over time, to push manufacturing productivity further, a CMM must be able to adapt to varying measuring tasks regarding geometric part characteristics, inspection scope, accuracy requirements and measuring environment.

That's why manufacturers can further tailor the capabilities of each base model GLOBAL and Leitz Reference machine with options to meet their application needs best. A range of options can be selected during initial CMM configuration, with most able to be set up later as upgrades to the in-service machine.\*

This future-ready modularity enables flexible, cost-optimised system performance, ensuring GLOBAL and Leitz Reference CMMs are future-proof investments adaptable to manufacturers evolving needs now and in the future.

\* Options vary by CMM model.

# The identity of Hexagon's CMMs

Cutting-edge technologies ensure measurement reliability that manufacturers can trust

Only an efficient and reliable measurement process establishes confidence in a CMM and the quality of manufactured products.

GLOBAL and Leitz Reference CMMs are built on advanced design principles to inspire certainty and confidence. Each range combines quality components and state-of-the-art technologies for long-term stability, reduced measurement uncertainty, adaptability to harsh measuring environments, fast measuring point capture and an advanced user experience.

These metrology solutions will provide manufacturers with maximum value over the entire lifecycle.



● **Sturdy mechanical design**

The solid granite base with integrated dovetail guide guarantees long-term system stability and consistent accuracy over the entire measurement volume.

● **Temperature compensation**

Real-time compensation of thermally caused measurement deviations through temperature sensing at the scales and on the workpiece ensures reliable measurement results.

● **Real-time system monitoring**

PULSE enables the user to monitor and log any environmental conditions surrounding the CMM and receive real-time machine information.

● **High-speed and safety**

Continuous monitoring of a defined safety area around the CMM allows worry-free high-speed measurement in CNC mode. The machine will slow down automatically when the user or an object encroaches upon the protected area.

● **Bridge with triangular crossbeam**

Featuring an improved stiffness-to-mass ratio relative to square or rectangular traverses, this design allows for the highest dynamics and high-speed measurements.

● **Extended temperature operating range**

Measure your components with more resistance to environmental influences. An extended temperature operating range (15 - 30°C) allows the CMM to operate closer to the production line without needing a costly climate room.

● **Messaging lights**

Messaging lights give operators the ability to monitor the machine's status even from a distance, to optimise time and resource management.

● **Preloaded air bearings on all axes**

Contactless, low-friction and low-wear axis motion ensures fast and repeatable positioning at all speeds and accelerations, resulting in low measuring uncertainties.

● **Low-maintenance belt drive system**

Flat and V-ribbed belts ensure smooth and low-vibration axis motion.

● **Future-ready concept**

The future-ready pre-cabling enables easy adaptation of the CMMs to future measurement tasks without costly downtime. A range of adaptability options can be flexibly selected during initial CMM configuration or set up later as upgrades.

● **Multisensor versatility**

Using the widest range of tactile and optical sensors with Hexagon's universal sensor interface, the CMM becomes a multisensor inspection device that can adapt to the most complex measuring tasks with fully automatic sensor exchange during a measurement cycle.

# GLOBAL Touch+

## General-purpose measurements of size features with highly repeatable touch-trigger probing

Using a highly versatile and accurate 6-way touch-trigger probe with a motorised indexing probe head to flexibly position the probe during measurement, the GLOBAL Touch+ model is configured to provide outstanding tactile single-point measurement performance on prismatic parts.

Optimal feature accessibility and minimised stylus changes are guaranteed even for the most intricate 3D part geometries. In addition, a multi-port module changer rack allows fast and repeatable changing of probe modules with different trigger forces and styli configurations without recalibration, further contributing to streamlining measuring cycles.

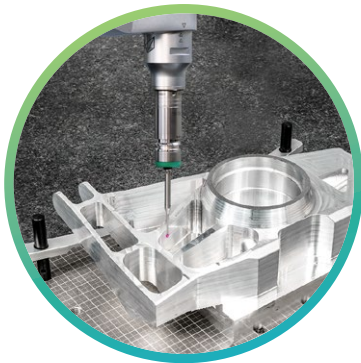

Machined  
mechanical  
parts

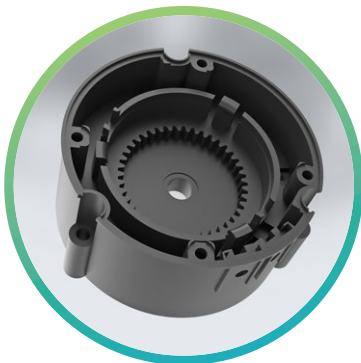

Plastic injection  
moulded parts

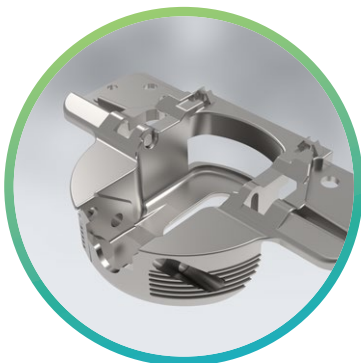

Hinge joints

### Challenges

General-purpose measurement of size features

- Parts of varying complexity and size
- Standard geometric size features: distances, radii, angles, inner and outer diameters
- Position and orientation tolerances
- Complex 3D arrangement of geometric elements around the part

### Benefits

- Rapid inspection
- Simple methodology
- Versatile measurements
- CAD-based measurement

**Machine sizes available:** From 05.05.05 to 12.30.10

*For complete information about regional product availability, please contact a local Hexagon representative.*



**6-way touch-trigger probe mounted on an automatic probe head**

Highly repeatable 3D point measurement on all sides of a workpiece.

Fastest accessibility to complex geometries with difficult-to-reach measuring positions.



**Flexible probe module changer rack**

Adjust configurations to the application with automated exchange of probe modules during the measurement routine without recalibration.



# GLOBAL Scan+

## General-purpose measurements of size and form features with high performance tactile scanning

GLOBAL Scan+ adds tactile scanning to the range of possible applications. With tactile scanning, a large number of surface points are captured within a short time, enabling highly accurate form and profile measurements on functional parts.

GLOBAL Scan+ combines tactile scanning capability with the flexibility of an automatic probe head. The scanning probe can be positioned at various spatial angles, making accessing more complex workpieces easy. An accompanying styli changer rack accelerates the inspection process by enabling fast changes of styli configurations within a measuring program without restricting the available measurement volume.

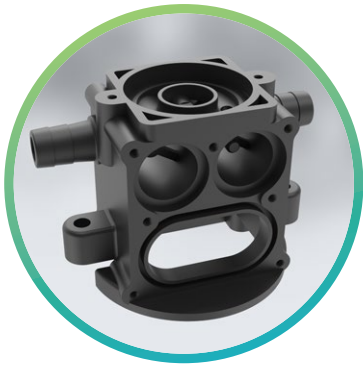

Housings



Gearboxes

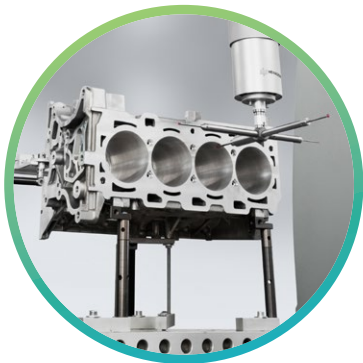

Engine blocks

## Challenges

General-purpose measurement of size and form features

- Functional fit assessment
- Assembly parts with narrow form tolerances: straightness, flatness, roundness, cylindricity, line/surface profile
- Efficient in-line measurement of the most complex part geometries with high precision

## Benefits

- Measurement of features with tolerances in a low micron range
- High scanning speed and measuring throughput
- High measuring point density for an accurate evaluation of form errors
- CAD-based scan path creation, 3D simulated collision checks and probe path optimisations, real-time part-to-CAD comparison and GD&T analysis

**Machine sizes available:** From 05.05.05 to 20.40.15

*For complete information about regional product availability, please contact a local Hexagon representative.*



**Tactile scanning probe mounted on an automatic probe head**

Fast and accurate contour and form measurements with the best-suited orientation due to flexible sensor positioning.



**Styli changer rack outside the measurement volume**

Automatically exchange styli configurations without restricting the measuring volume.



# GLOBAL Optics

## Optical high-resolution measurements of miniature size and form features on challenging surfaces

Equipped with a chromatic white light sensor as standard, GLOBAL Optics is ideal for non-contact measurement of the geometric size and form characteristics of sensitive workpieces that cannot be touched and those with particularly challenging surfaces.

An indexing probe head provides excellent access to part features from almost any angle and direction, allowing optimal alignment of the chromatic white light sensor to the measured surface. Furthermore, in combination with an automatic sensor changer rack, and thanks to Hexagon's opto-mechanical sensor interface, different sensors can be easily exchanged on the indexing probe head, maximising the CMM's multisensor flexibility.



Orthopaedic implants

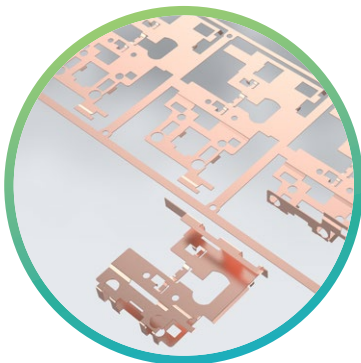

Stampings, stamping strips

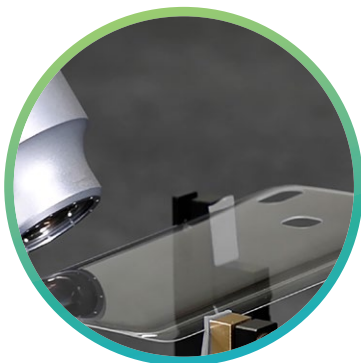

Display glass for mobile devices

### Challenges

Non-contact size and form measurements on varied part surfaces

- Soft and sensitive parts that cannot be touched
- Very small geometries (microgeometries)
- Varied materials and surface finishes: matte / transparent / reflective, microstructured, coated

### Benefits

- Optical high-resolution measurement for capturing the smallest geometric structures
- Single-point distance measurement and scanning of freeform surfaces
- Surface-independent measurements
- Thickness measurements on transparent materials

**Machine sizes available:** From 07.07.05 to 20.40.15

*For complete information about regional product availability, please contact a local Hexagon representative.*



**Optical white light sensor mounted on an automatic probe head**

Highly accurate non-contact measurements of 3D microstructures and scanning of freeform surfaces on varied surface finishes.



**6-way touch-trigger probe mounted on an automatic probe head**

Fast and accurate workpiece alignment and basic measurements with single-point probing.



**Automatic sensor changer rack**

Adapt to specific application needs with fast and repeatable exchanges of sensor and styli configurations.

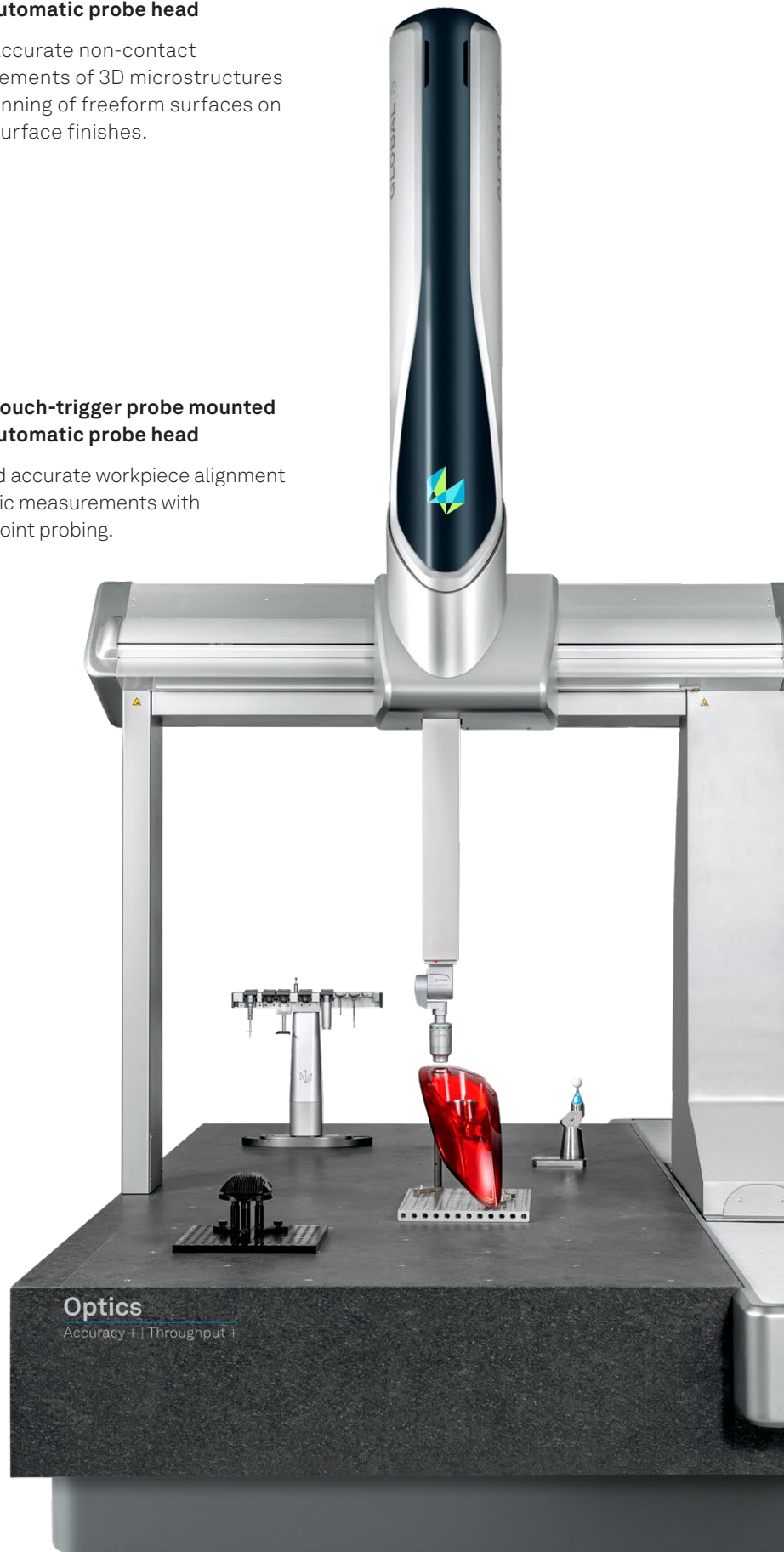

# GLOBAL Speed

## High-throughput measurements of complete part surfaces with high measuring point density

GLOBAL Speed is equipped with Hexagon's cutting-edge laser scanning sensor as standard, combining unmatched speed, accuracy and flexibility to streamline the complete non-contact point cloud capture of freeform surfaces.

For applications ranging from complex-shaped housings to turbine blades, measuring entire part surfaces in point clouds without compromising throughput becomes a straightforward task thanks to the laser scanner's ability to capture up to 600 000 points per second. Highly accurate data is then available for comparison with nominal CAD data or reverse engineering.

An indexing probe head ensures the sensor is always optimally aligned with the workpiece surface being measured, while an automatic sensor changer rack allows the fully-automatic exchange of the laser scanner with other tactile or optical sensors during the measurement routine.



eMobility hairpins



Blades



Metal components

### Challenges

High-throughput capture of complete part surfaces in point clouds

- Freeform surfaces
- Multi-material surfaces
- Full surface form deviation analysis with actual to nominal comparison
- Reverse engineering

### Benefits

- High-throughput full surface measurements
- 100% inspection of size and profile
- Streamlined tool development with fewer correction loops, faster process optimisation, reduced rejects and rework

**Machine sizes available:** From 07.07.05 to 20.40.15

*For complete information about regional product availability, please contact a local Hexagon representative.*



**Laser scanning sensor mounted on an automatic probe head**

Highly accurate and fast capturing of complex part surfaces with high measuring point density.

Unique usability features for fast and easy programming and handling.



**6-way touch-trigger probe mounted on an automatic probe head**

Fast and accurate single-point probing and workpiece alignment.



**Automatic sensor changer rack**

Maximised multisensor flexibility from automatic sensor and styli exchange during the measurement routine.



# Leitz Reference Precision

## High-precision fixed probe head measurements of tight tolerance parts

Leitz Reference Precision combines high accuracy and precision with outstanding high-speed scanning capabilities.

The model's fixed scanning head ensures high, repeatable accuracy even with extra-long probe extensions and heavy styli clusters. This enables users to use high-accuracy scanning across a broader range of measurement applications, including inspecting features deep within parts. In addition, a modular sensor and styli changer rack enables the selection of the best styli options for each application.



Precision tool holder

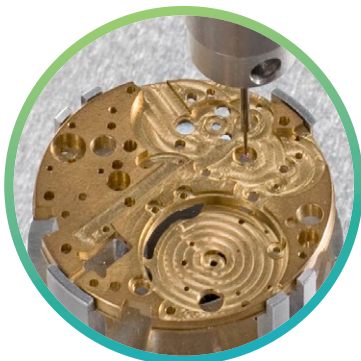

Watch plates



Tight tolerance precision gears

## Challenges

Highly accurate measurement of size and form features

- Tight tolerance functional form features: straightness, flatness, roundness, cylindricity, line/surface profile
- Filigree structures and microgeometrical features
- Measurement of special geometrical features
- Rotationally symmetric parts

## Benefits

- High measurement system capability (Cg, Cgk, Gauge R&R)
- Maximum accuracy and repeatability, even when using long and heavy styli configurations
- Low force probing to avoid part bending or damage
- Evaluation of all geometrical gear parameters
- Non-contact measurements with chromatic white light and interferometric sensors
- Simultaneous 4-axis scanning – optical or tactile – in combination with a rotary table

**Machine sizes available:** From 05.04.03 to 40.12.09

*For complete information about regional product availability, please contact a local Hexagon representative.*



### Fixed scanning probe

High accuracy form and profile measurements with high flexibility using heavy and long styli configurations.



### Modular sensor and styli changer rack

Uninterrupted measurements with automatic multi-styli use within a single part program to adapt to different measurement tasks.



# Leitz Reference Flexibility

High-precision measurements of tight tolerance parts with maximum application adaptability

Leitz Reference Flexibility builds upon the capabilities of the Precision configuration to boost the machine's adaptability to more challenging measurement tasks and decrease cycle time.

The CMM has an articulating probe head that measures at any angle to add accessibility to complex 3D part geometries. In addition, the SENMATION sensor automation system increases measurement flexibility by seamlessly integrating a variety of tactile and optical sensors within one measurement routine to address multi-part or multi-feature applications.



Powertrain components

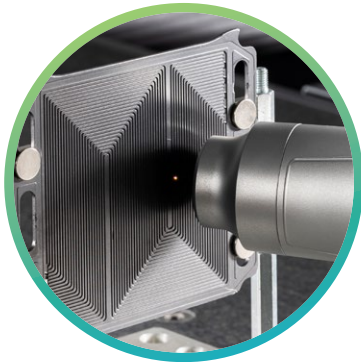

Bipolar plates for fuel cells



Compressor wheels

## Challenges

Highly accurate measurement of the most complex geometries with decreased cycle time

- Large variety of parts with different measurement requirements
- Complex 3D geometries with tight tolerances
- Functional size and form features in hard-to-access spatial orientations around the part
- Various material types and surface characteristics

## Benefits

- High-throughput and versatile multisensor measurements
- Easy access to complex workpieces with a motorised indexing probe head
- Extended application adaptability and future-readiness with the SENMATION sensor automation system
- Non-contact measurements with chromatic white light, interferometric and laser scanning sensors
- Simultaneous 4-axis scanning – optical or tactile – in combination with a rotary table

**Machine sizes available:** From 07.07.05 to 40.12.09

*For complete information about regional product availability, please contact a local Hexagon representative.*



**Tactile scanning sensor mounted on an articulating head**

Fast contour and form measurements with flexible sensor positioning to measure features at the optimum angle.



**SENIMATION sensor automation system with modular sensor and styli changer rack**

Uninterrupted measurements with fully automatic sensor exchange within a single part program to adapt to the most complex measurement tasks.



# Enhancement options

## Ultimate accuracy levels for the tightest tolerances

**Accuracy+** reduces the CMM's volumetric measurement error to the next level of accuracy and increases repeatability to address tighter part tolerances. The need for such capability is a growing trend in many industries. For Leitz Reference models, **Accuracy++** enables even better accuracy.

## Higher production volume and faster output

Throughput is key to avoiding delays and ensuring parts are shipped on time. High measurement throughput is particularly important for near-line and 100% part inspection. **Throughput+** boosts measurement productivity of GLOBAL CMMs by significantly increasing the machine's maximum measurement speed without compromising accuracy or precision.

## Wider operating temperature range

The **XT** (extended temperature) option allows GLOBAL and Leitz Reference CMMs to be used in less controlled temperature environments, enabling accurate and reliable measurements near the production line without needing a costly climate room.

# Various exchange options

## Switch probe heads, sensors, probe modules and styli

From styli to complete sensor systems, for frequent or occasional application changes, Hexagon's solutions enable uninterrupted measurement. Depending on your machine, choose between versatile rack systems, MAC manual head exchange, available as an option on some GLOBAL models, or the SENMATION intelligent sensor automation system, which is standard on mid- and large-size Leitz Reference Flexibility models.



# Measurement capabilities for specific tasks

## SENMATION: Intelligent sensor automation for Leitz Reference Flexibility models

With fully automatic sensor exchange, **SENMATION** transforms the Leitz Reference Flexibility CMM into a multisensor inspection device capable of completing the most intricate measurement tasks. The system enables the use of a wide variety of tactile and optical sensors within the same measurement routine, ensuring the right type of sensor is used for every part feature.

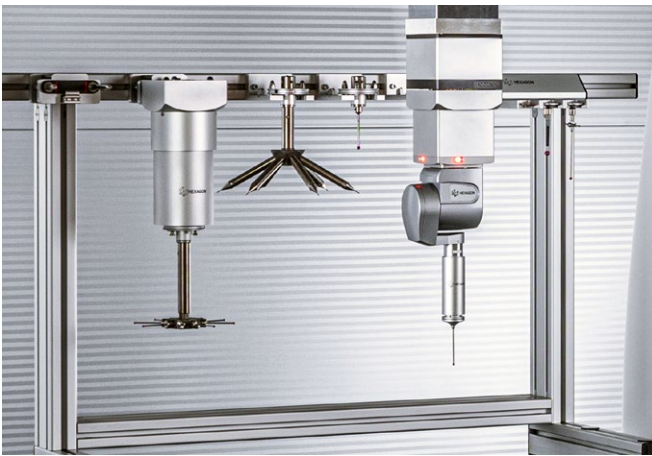

**SENMATION: Intelligent, fully automatic, futureproof.**

## 4-axis scanning: Measure highly complex parts using a rotary table on Leitz Reference CMMs

Coordinate measurement can reach its limits when inspecting parts that require multiple probe changes, such as very small and complex internal gearing or aero engine blisks. The optional use of a **rotary table** extends the CMM's capabilities to allow continuous **4-axis scanning** procedures. Rotary tables enable access to workpieces from any angle, so even highly complex parts can be scanned quickly, with fewer probe changes, increasing throughput.



# Get the job done easier

It's one thing to have a CMM fit for any measurement challenge, but to get the job done efficiently, each part of the metrology process must fit production and operator needs. That's why Hexagon also invests strongly in solutions around measurement devices like CMMs and portable devices to make the life of operators easier and improve manufacturing productivity.

## Optimise machine utilisation with off-the-shelf options

CMMs operate within production ecosystems with various workflows, where there are usually good opportunities for productivity improvement. Manufacturers increasingly combine their CMMs with intelligent solutions to create smart connected systems that boost process efficiency and product quality.

Benefits include:

- Greater measurement throughput
- Better ergonomics, ease of use and workplace safety
- Reduced production bottlenecks
- Autonomous process flow with off-shift measurement

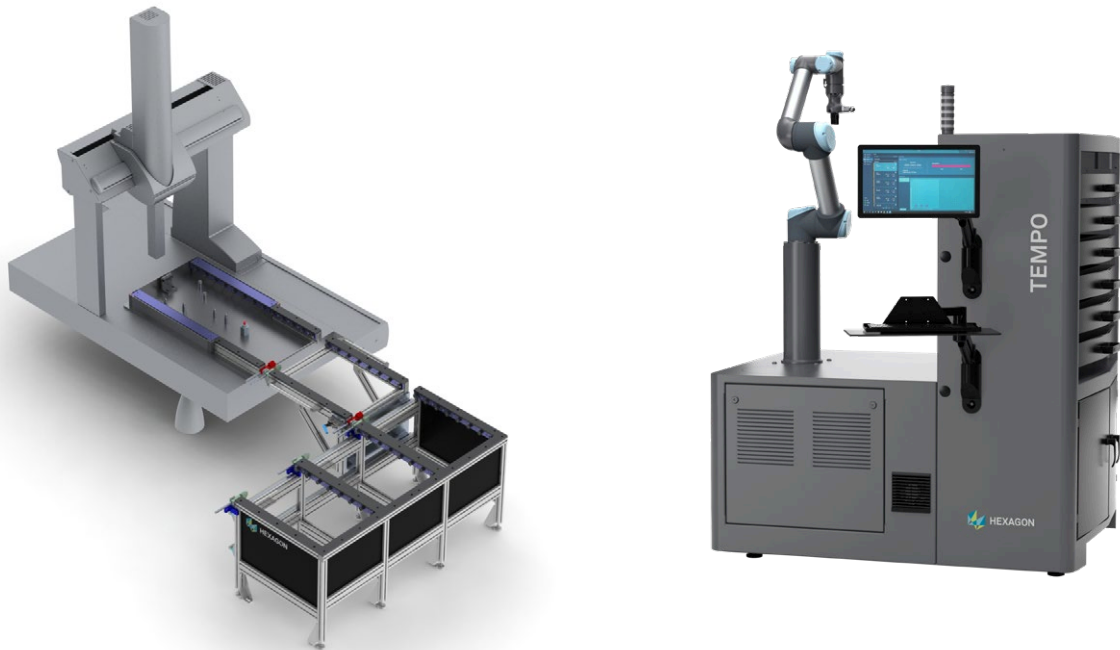

## Reduce idle time with fast, easy part feeding

Shifting set-up work away from the CMM can improve workflow and eliminate bottlenecks. Whether for single parts or multiple fixtures with different components, Hexagon's manual loading systems allow measurement configurations to be set up away from the CMM and then quickly and safely moved into the measuring area with the help of shuttle systems or trolleys.

## Smart workflow integration

Hexagon's off-the-shelf TEMPO automated loading system helps manufacturers integrate quality assurance into smart production environments. TEMPO orchestrates the measurement process by automating part loading, queuing and unloading to enable continuous measurement without operator intervention for hours, entire shifts and even lights-out production. Operators are freed to focus on value-added tasks where their expertise is needed most.

# Boost usability and efficiencies around the measurement process

Hexagon's range of accessory products for CMMs helps machine operators more easily master their daily challenges to achieve better results faster.

Responding to customer needs, Hexagon continues to develop accessories that improve usability in several areas of the inspection process, from setting up measurement devices to storing accessories.



Styli setting devices for fast, reliable set-up



Part fixturing options for any measurement configuration



Testing artefacts for regular health checks to avoid downtime



Enclosures to protect CMMs from harsh environments



Cabinets for storage and protection of measurement equipment



Workstations and trolleys for workplace organisation



## Accessories

### Making the most of 3D metrology

Driven by a truly end-to-end approach to innovation, Hexagon's wide range of accessory products reaches from added functionality to improved productivity while covering every need in between.

Hexagon's Manufacturing Intelligence online shop offers a streamlined search, order and delivery service for a wide range of accessories and spare parts in many countries worldwide. Whether you're buying single items or in bulk, [shop.hexagonmi.com](http://shop.hexagonmi.com) takes the time and stress out of securing the measuring equipment you need.

# Comprehensive software

Developed to provide the best support

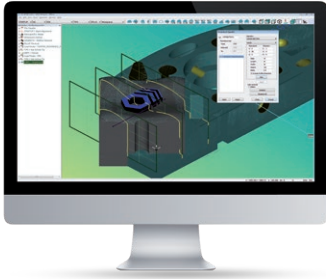

## PC-DMIS

PC-DMIS has powerful capabilities to enable users to measure everything from simple prismatic parts to the most complex aerospace and automotive components. PC-DMIS is available in two basic configurations: CAD and CAD+, with optional modules available to fine-tune the software for specific applications.

## Smart productivity enhancements

Bundled software modules allow users to adapt to individual production objectives. Cost effective, easy and available pre-installed or as later additions.

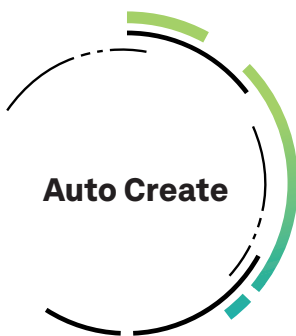

### Auto Create

Automated measuring routine creation online and offline – extract information right from CAD and eliminate data interpretation and input errors, including:

- PC-DMIS Offline
- Direct CAD Translator | Direct CAD Interface
- GD&T Selection



### Industrial Integration

Measure near the production line – detect process variations earlier and apply corrective actions faster.

- Inspect Automate – Barcode/Pallet/Playlist
- Notification Centre
- I/O interface



### Traceability

Comply with the requirements of highly regulated industries – have confidence in the integrity and reliability of your measurement results.

- PC-DMIS Protect
- PULSE, real-time monitoring for metrology environments



### Cycle Time

Keep up with the demands of your production process – maximise inspection throughput by reducing the set-up and execution time of a measurement part program.

- Path Optimiser
- Flex Inspect
- MultiCapture
- Template Matching
- Fly2 Mode



### Reporting

Informed and timely decision making – extract actionable information from your measurement data.

- Metrology Reporting

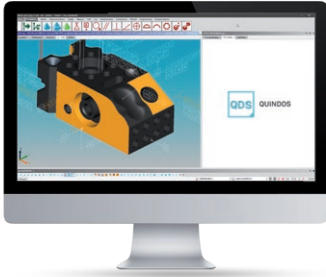

## QUINDOS

QUINDOS is the specialist, expandable software that sets the standard for special geometry metrology. Developed to work in partnership with Hexagon Manufacturing Intelligence ultra-high accuracy measuring machines, nearly every measurement task can be solved for a wide variety of different components. QUINDOS can be freely configured for any measurement requirement and expanded later if required using any combination of over 50 available options. All performance and evaluation of measurements are carried out in accordance with the respective national and international standards.



## Q-DAS

Reliable quality data is a vital tool for process evaluation and control. Q-DAS provides the software and the service for the efficient and reliable application of statistical methods necessary to set up a quality ratio system in industrial production.

# Metrology Asset Manager

Real-time performance data in a centralised user-friendly dashboard, now as standard

Hexagon's Metrology Asset Manager delivers a simple, accurate and reliable way to monitor and analyse how key assets are performing via a centralised, user-friendly dashboard, whether on a single site or distributed across multiple locations around the world.

This future-proof solution provides manufacturers with easy and intuitive access to important information in real-time to allow for better informed decision making. Smart measurement and smart monitoring are the future of smart manufacturing.

- Monitor and manage device status, usage and performance
- Securely access information from anywhere in real time
- Identify production bottlenecks and other sources of inefficiency
- Receive customisable critical event notifications
- Track assets across a single site or at multiple worldwide locations

Every Hexagon CMM comes bundled with a one-year Metrology Asset Manager Advanced subscription. Contact your local Hexagon representative for more details.

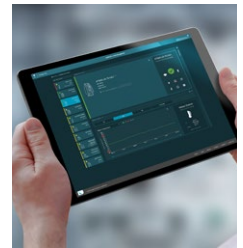
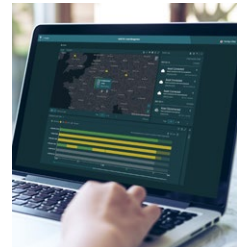

## Metrology Asset Manager

neXus APP



## Greener metrology

### Save energy

To achieve global sustainability goals, much faster progress is needed in reducing the energy required to provide products and services. The energy consumption of a CMM is driven mainly by the supply of compressed air needed for a smooth run of the axis driving system.

Energy-saving features are standard on all Hexagon GLOBAL CMMs, giving manufacturers a green light to more responsible, more sustainable metrology.

# Service and support

## World-class products to rely on

Drawing on decades of research and development experience, CMM technology from Hexagon's Manufacturing Intelligence division is built on a long history of outperforming technological innovation. Deriving quality from experience to drive productivity is what keeps Hexagon in front and able to deliver first-class solutions for industries around the world.

That's why Hexagon CMMs come with a factory warranty of up to 24 months and a guaranteed 10 years of serviceability through official Hexagon service channels.

## World-class support delivered locally

The international presence of Hexagon guarantees comprehensive aftersales support and services across the globe. With the largest dedicated service team of any metrology equipment manufacturer and an emphasis on locally delivered solutions, Hexagon is unmatched from service, repair, certification and calibration through operator training and software maintenance and upgrades.

● Customer and demo centre





Hexagon is a global leader in digital reality solutions, combining sensor, software and autonomous technologies. We are putting data to work to boost efficiency, productivity, quality and safety across industrial, manufacturing, infrastructure, public sector, and mobility applications.

Our technologies are shaping production and people-related ecosystems to become increasingly connected and autonomous – ensuring a scalable, sustainable future.

Hexagon's Manufacturing Intelligence division provides solutions that use data from design and engineering, production and metrology to make manufacturing smarter.

Learn more about Hexagon (Nasdaq Stockholm: HEXA B) at [hexagon.com](https://www.hexagon.com) and follow us [@HexagonAB](https://twitter.com/HexagonAB).