

2-1-3. Arbeitsbereich

Eingefügt ist eine Draufsicht des benötigten Arbeitsbereiches für die Maschine

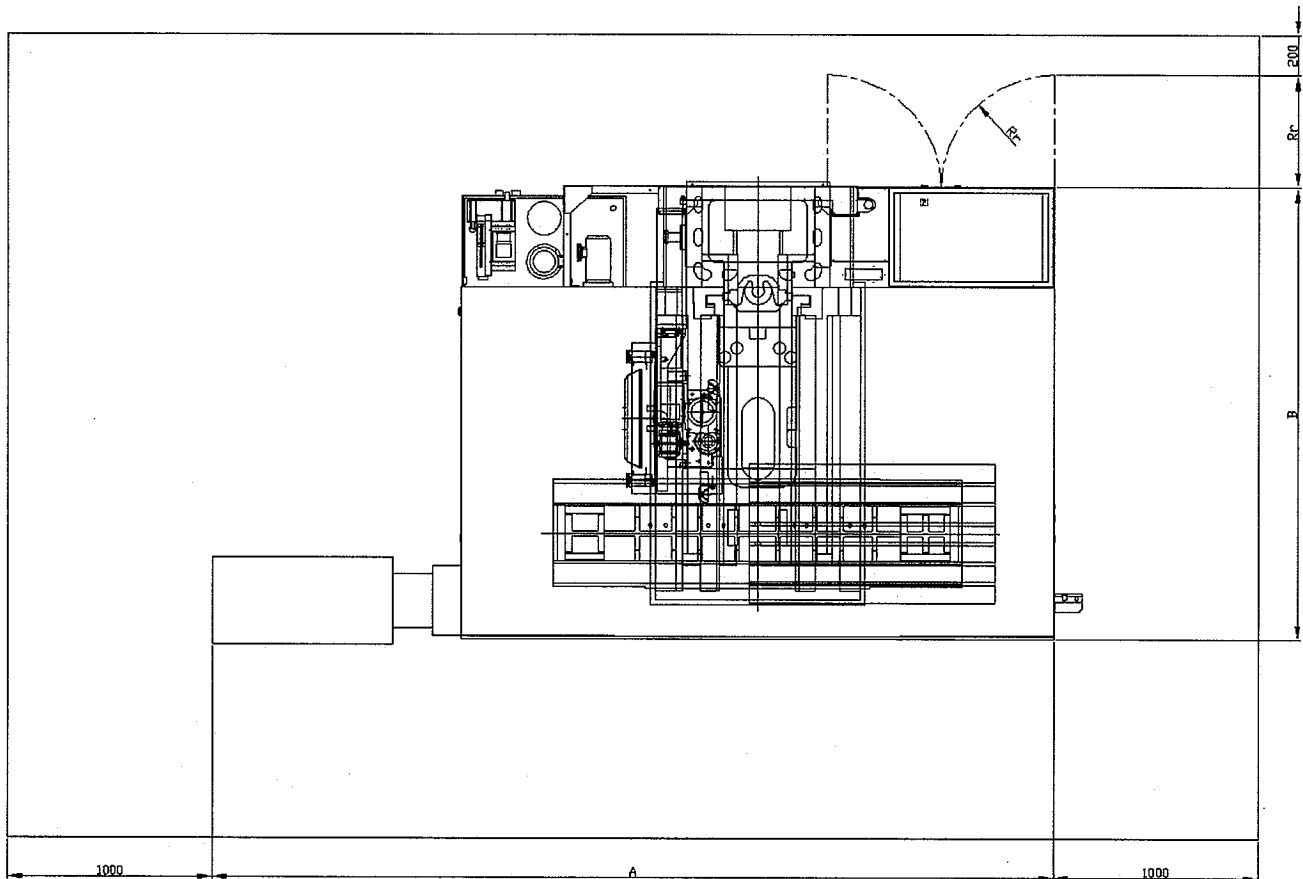







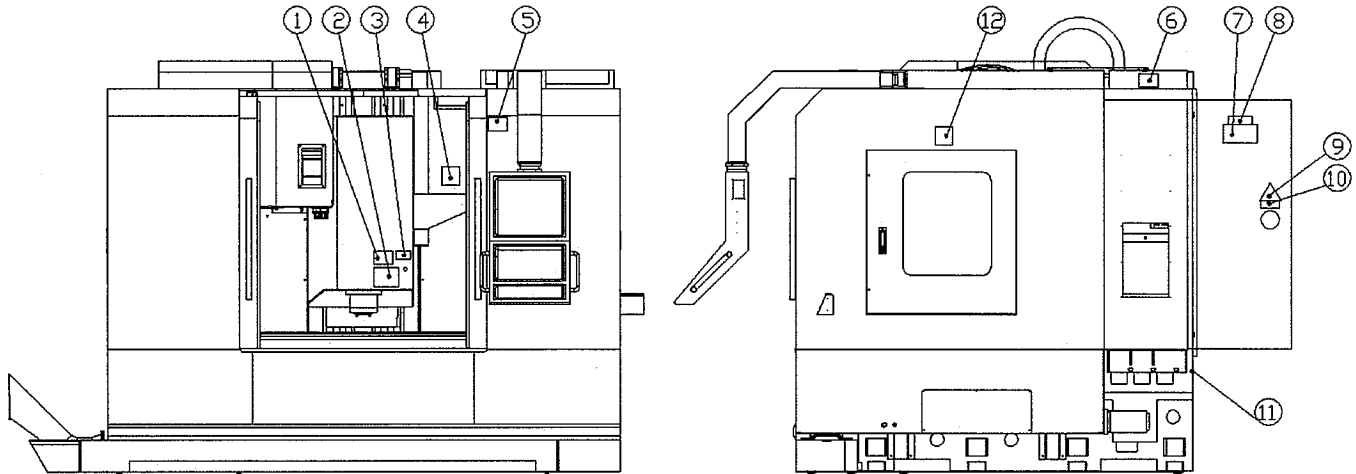

	A	B	Rr
MMV-1100 S	3020	2050	985

Einheit: mm

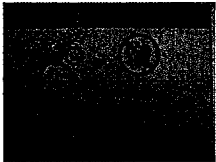
2-1-4. Warnschilder der Maschine

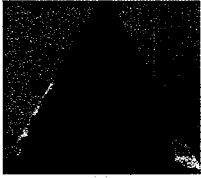
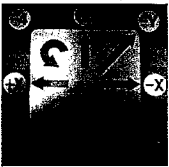
1. Wichtige Sicherheitsinformationen sind als Warnschilder an der Maschine angebracht. Diese müssen von jedermann befolgt werden.

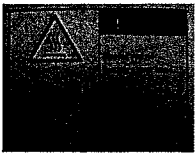

1.		7.	
2.		8.	
3.		9.	
4.		10.	
5.		11.	
6.		12.	