

A-A

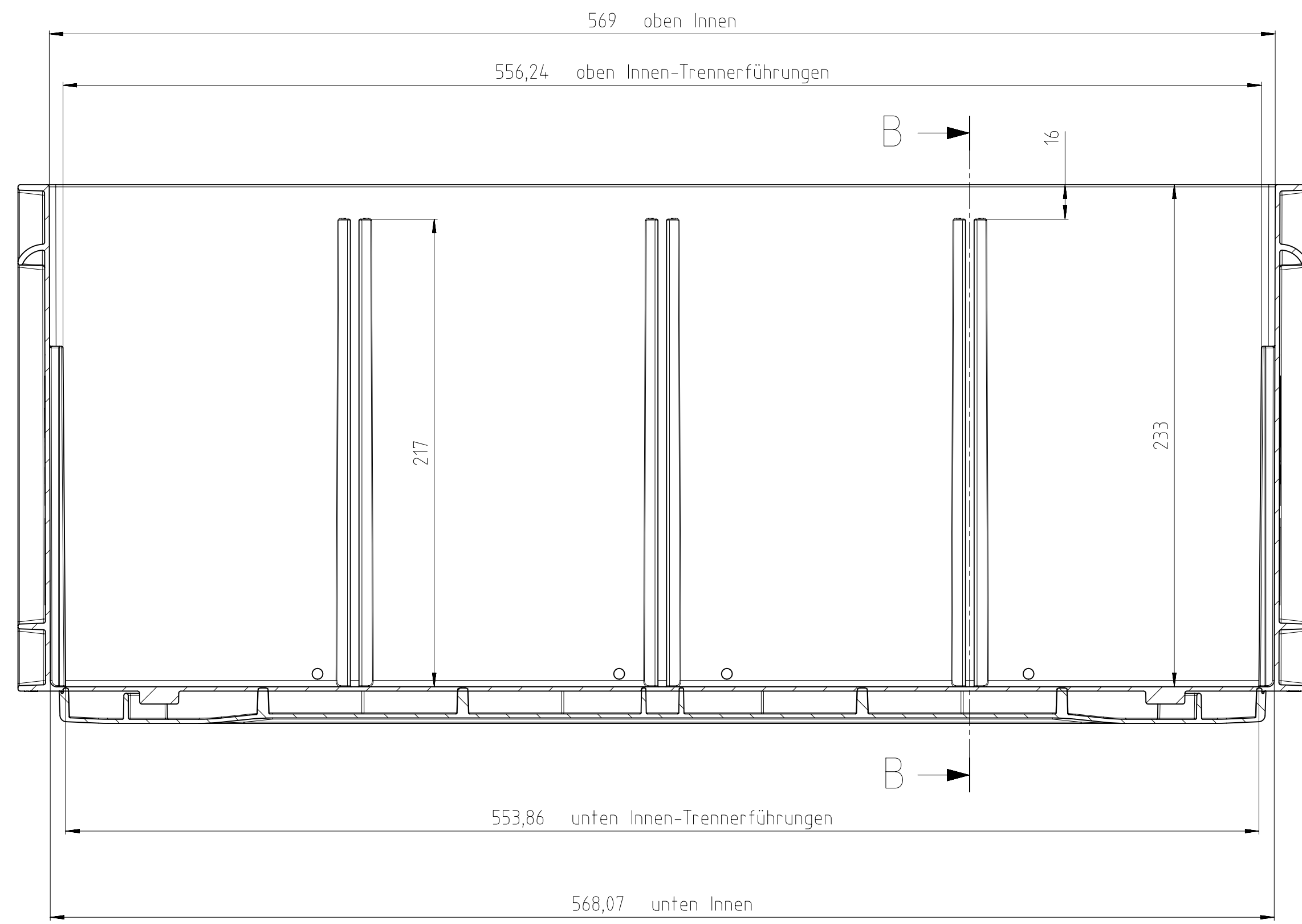

B-B

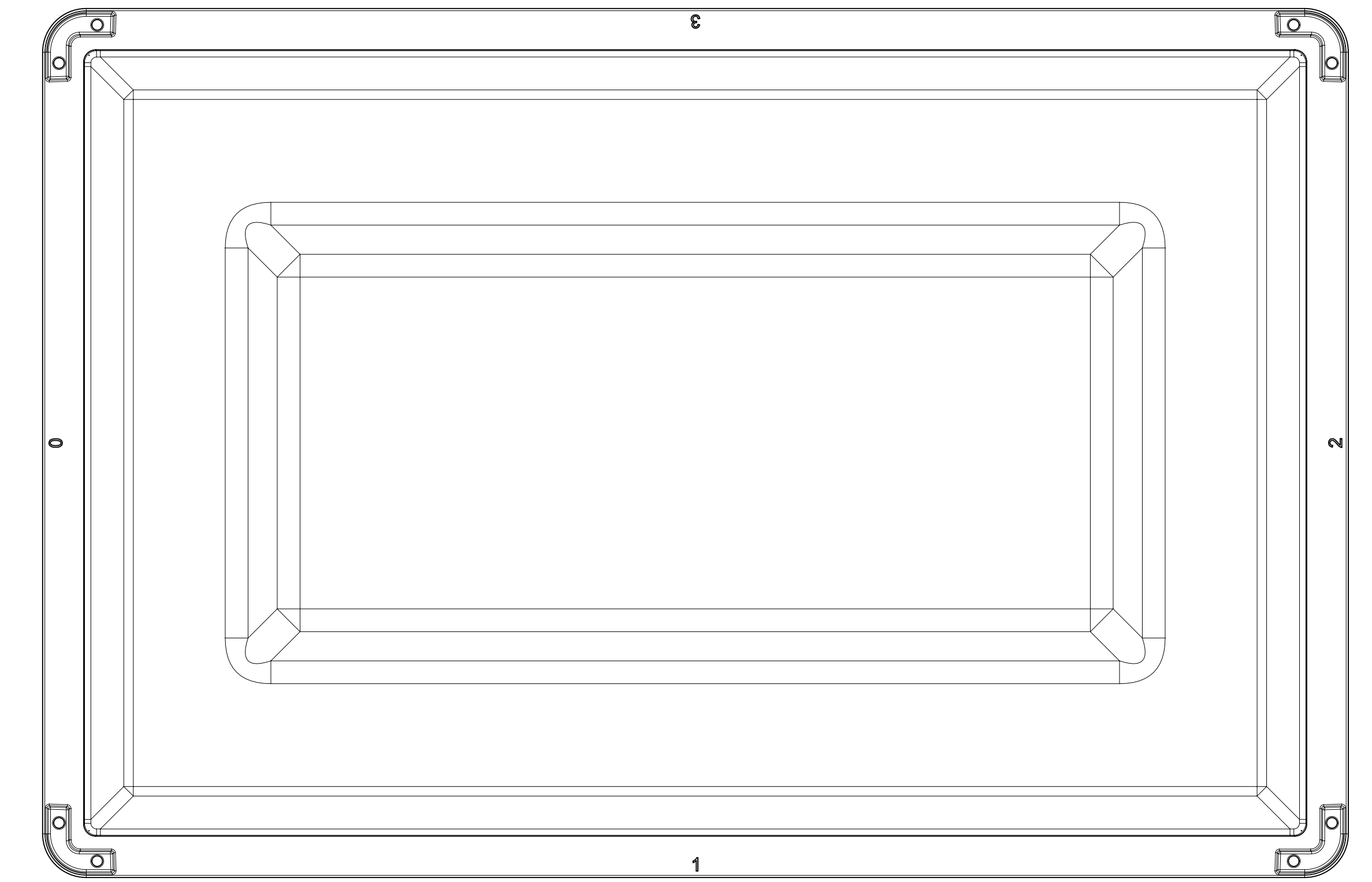
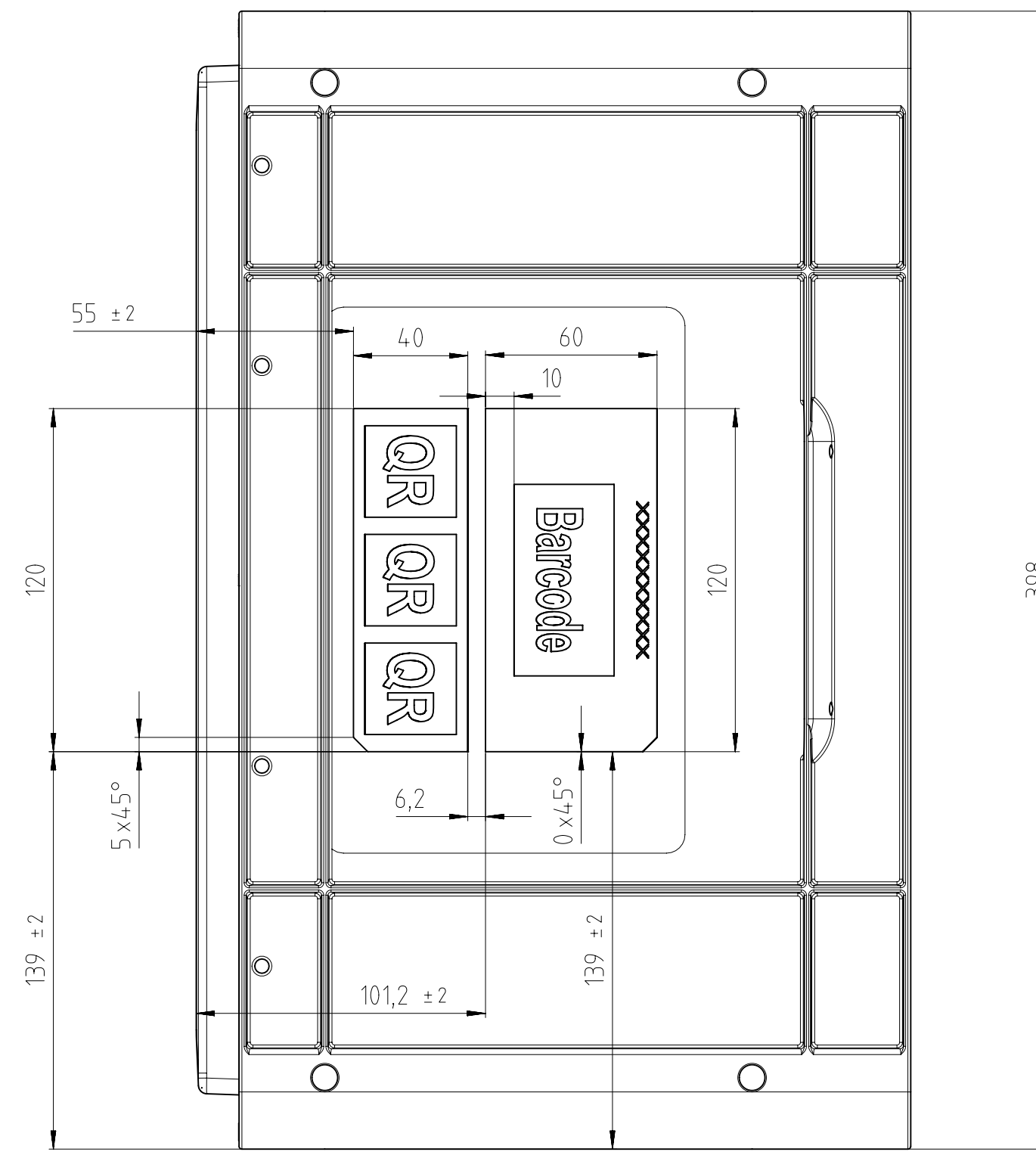
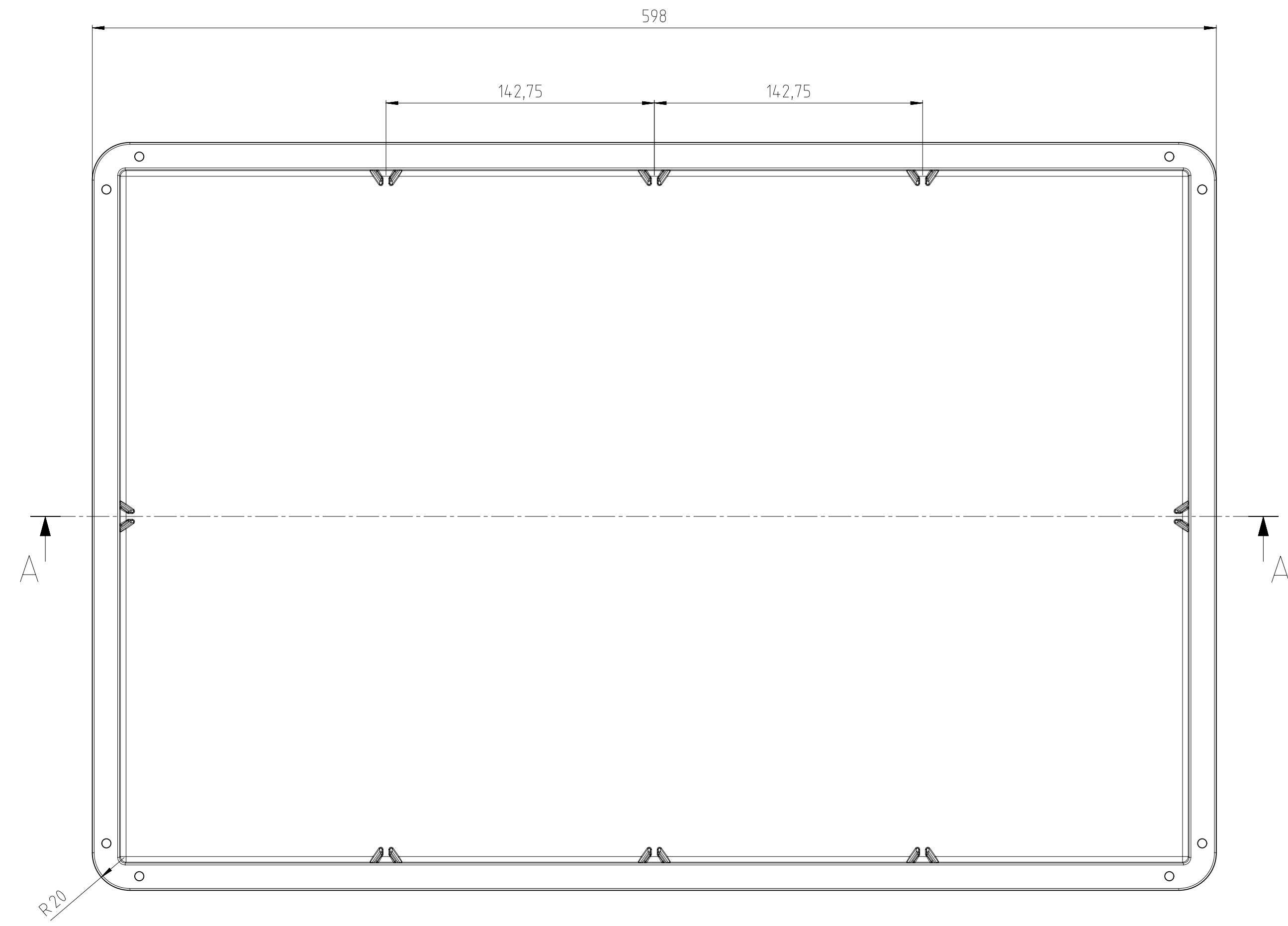
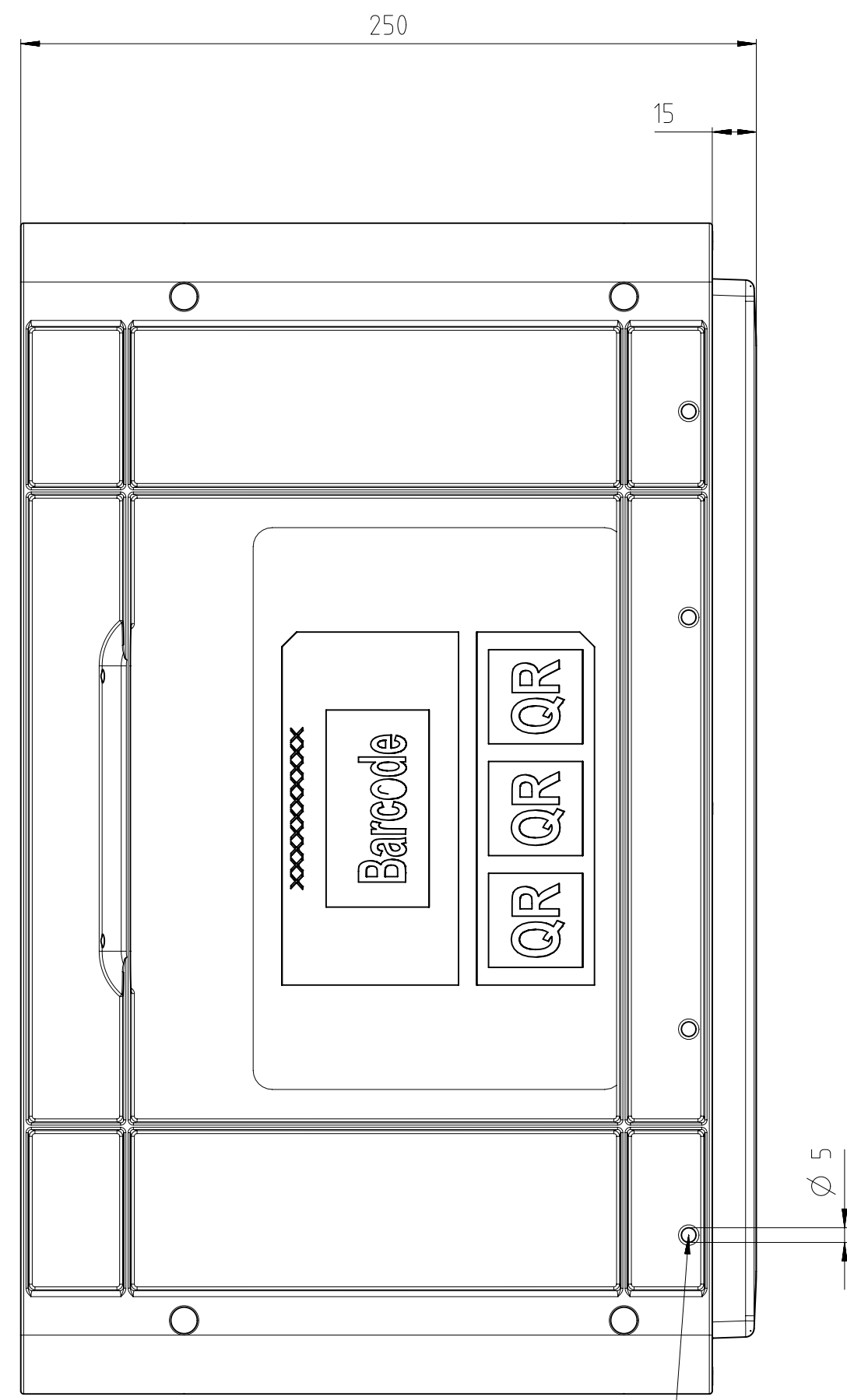
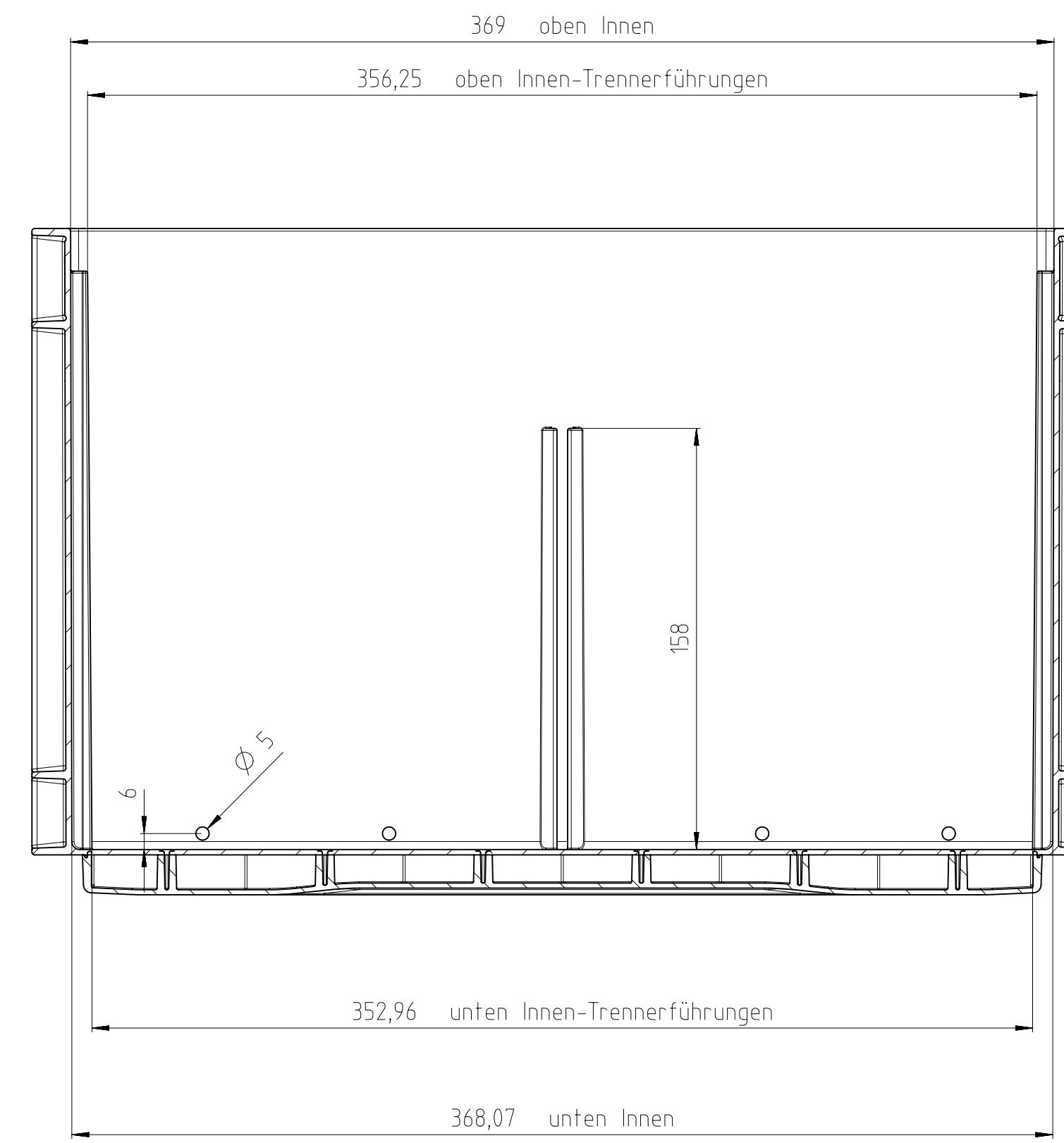

Wasserablaufbohrungen nicht gegenüberliegend je 4x LS und KS

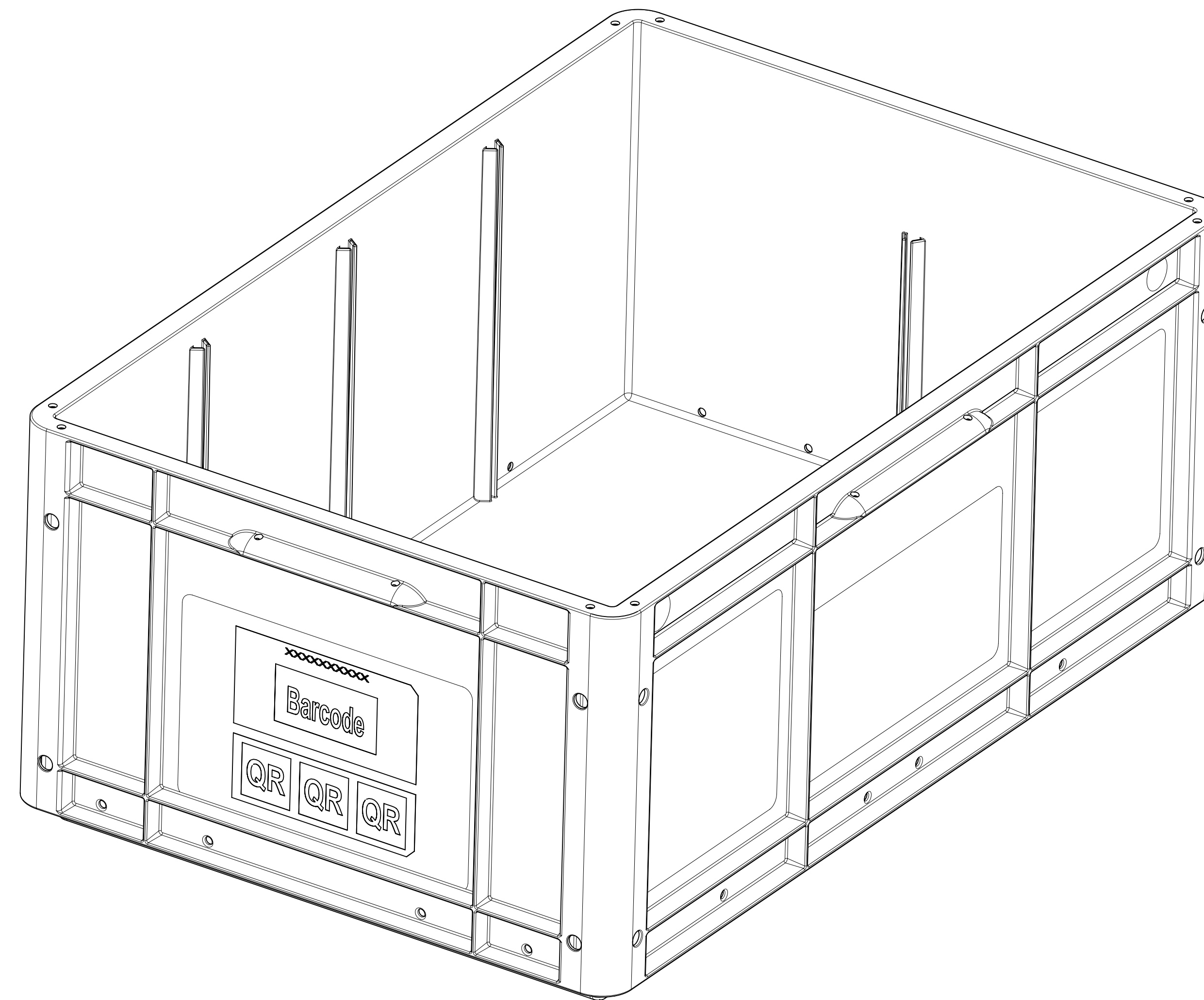
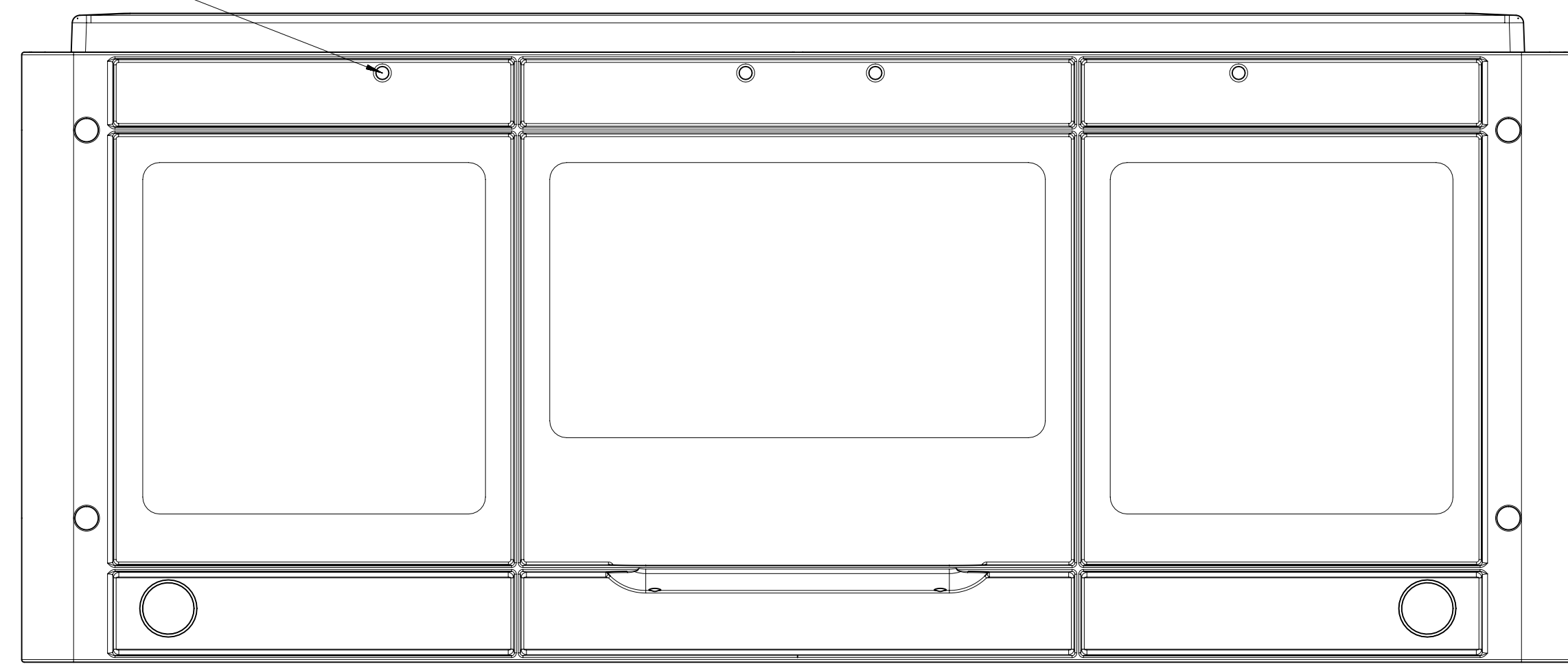

drawing for approval
 the drawing is approved
 company stamp :
 date :
 signature :
 You must resend the released drawing by
 post according to our quality system
 ISO 9001:2015
 Thank you in advance

15-6425-789-V	010903	010908	1	Europac ASM	SP	SM/MS/MS/MS					
SP/MS/MS/MS	SP/MS/MS/MS	SP/MS/MS/MS	SP/MS/MS/MS	SP/MS/MS/MS	SP/MS/MS/MS	SP/MS/MS/MS	SP/MS/MS/MS				
1:2	1:2	1:2	1:2	1:2	1:2	1:2	1:2				
Description: Europac ASM Material: PP Color: white Dimensions: 598x318x139 mm Weight: 1,2 kg Tolerance: ± 0,2 mm Surface finish: smooth Markings: Barcode, QR codes				Date: 05 May 2023 Drawn by: S. Rensing Checked by: S. Rensing Date: 16 Aug 2023 Drawn by: S. Rensing Checked by: S. Rensing				Project: 15-6425-789-V Drawing: 010903 Version: 1 Status: Approved			
Revision history: index notes date name				utzgroup.com				15-6425-789-V 1255586 2			